

NATIONAL INDUSTRIES

11781

CURTAIN WALL

SEC. NO:-11781

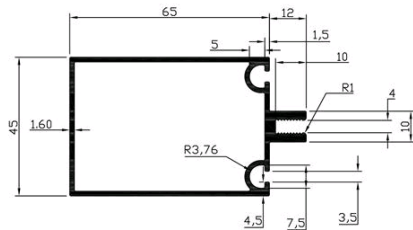

WEIGHT:- 6.185-6.300 kg/12'

CURTAIN WALL

11786

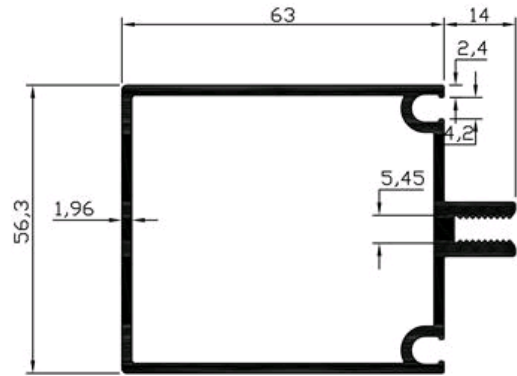

WEIGHT:- 5.561 kg/12'

CURTAIN WALL

11791

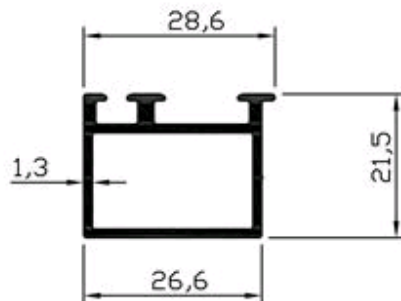

WEIGHT:- 1.400-1.600 kg/12'

CURTAIN WALL

11796

DRG.NO.:- 11796

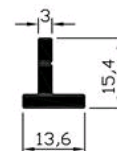

WEIGHT:- 0.767 kg/12'

CURTAIN WALL

NATIONAL INDUSTRIES

11806

SEC. NO:-11806

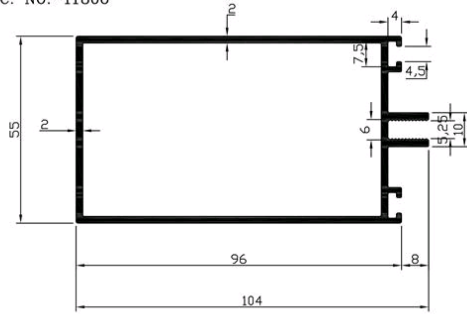

WEIGHT:- 6.505 kg/12'

CURTAIN WALL

11808

SEC. NO:-11801

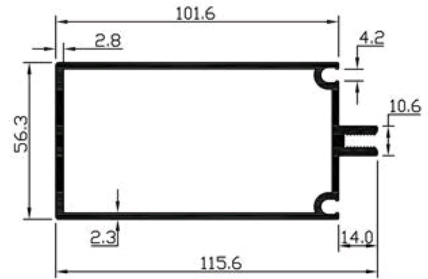

WEIGHT:- 8.300-8.800 kg/12'

CURTAIN WALL

11811

SEC. NO:-11811

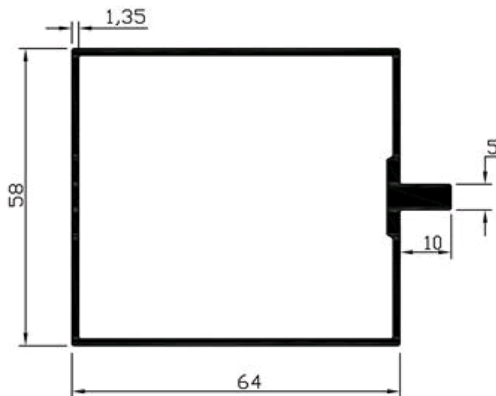

WEIGHT:- 3.800-4.200 kg/12'

CURTAIN WALL

11821

NO:-11821

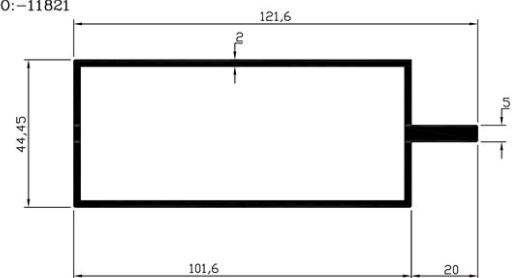

WEIGHT:- 6.600-7.000 kg/12'

CURTAIN WALL

NATIONAL INDUSTRIES

11826

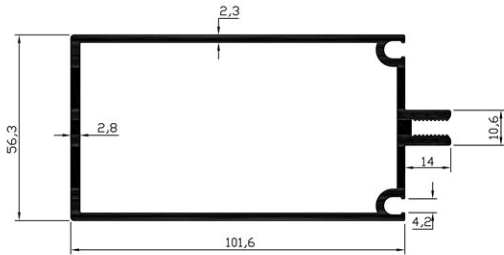

WEIGHT:- 8.300-8.800 kg/12'

CURTAIN WALL

11831

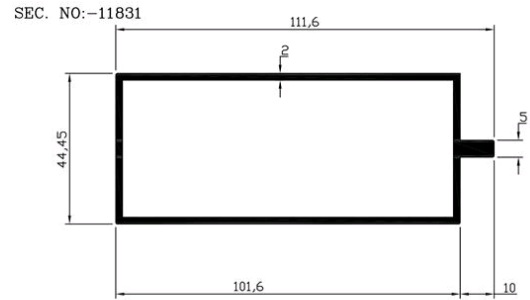

WEIGHT:- 6.100-6.500 kg/12'

CURTAIN WALL

11836

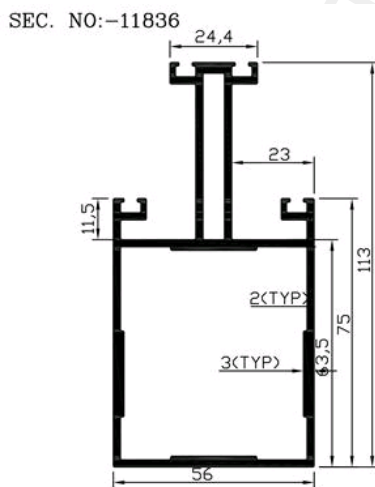

WEIGHT:- 9.000-9.500 kg/12'

CURTAIN WALL

11841

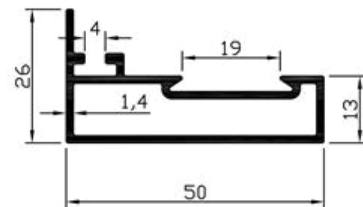

WEIGHT:- 2.100-2.300 kg/12'

CURTAIN WALL

NATIONAL INDUSTRIES

11846

CURTAIN WALL
SEC. NO:-11846

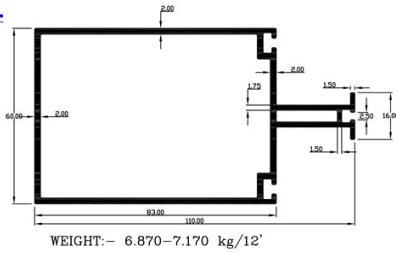

CURTAIN WALL

11866

SEC. NO:-11866
SEC. NO:- P-28

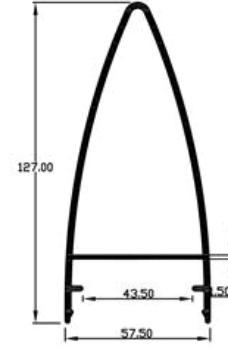

WEIGHT:- 6.800-7.100 kg/12'

CURTAIN WALL

11871

SEC. NO:-11871

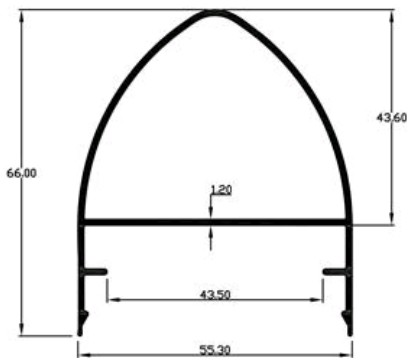

WEIGHT:- 2.550-2.700 kg/12'

CURTAIN WALL

11876

SEC. NO:-11876

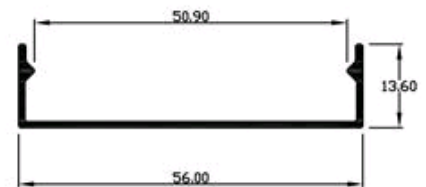

WEIGHT:- 0.860-0.960 kg/12'

CURTAIN WALL

NATIONAL INDUSTRIES

11881

SEC. NO:-11881

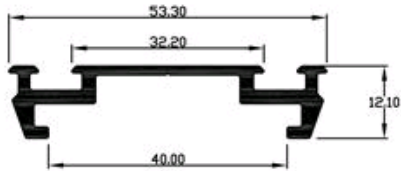

WEIGHT:- 1.750-1.850 kg/12'

CURTAIN WALL

13426

SEC. NO:-13426

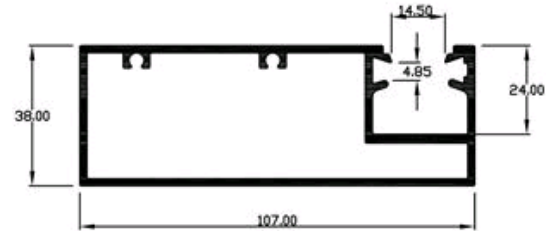

WEIGHT:- 6.700-7.000 kg/12'

CURTAIN WALL

13431

SEC. NO:-13431

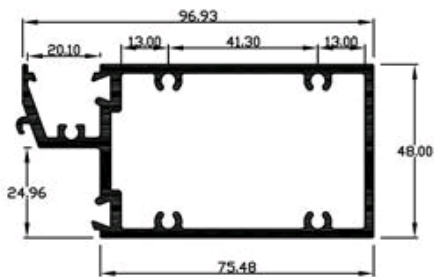

WEIGHT:- 8.095 kg/12'

CURTAIN WALL

13481

SEC. NO:-13481

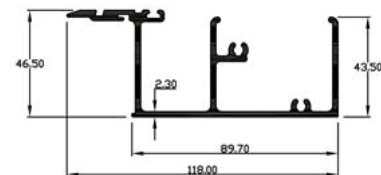

WEIGHT:- 6.900-7.300 kg/12'

CURTAIN WALL

NATIONAL INDUSTRIES

13486

SEC. NO:-13486

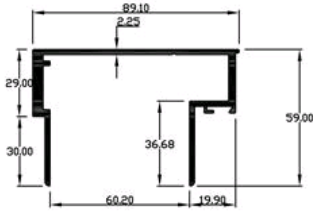

WEIGHT:- 5.850 kg/12'

CURTAIN WALL

13491

SEC. NO:-13491

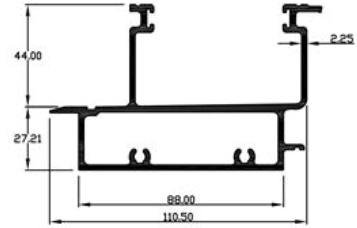

WEIGHT:- 9.500-9.900 kg/12'

CURTAIN WALL

13496

SEC. NO:-13496



WEIGHT:- 4.286 kg/12'

CURTAIN WALL

13501

SEC. NO:-13501

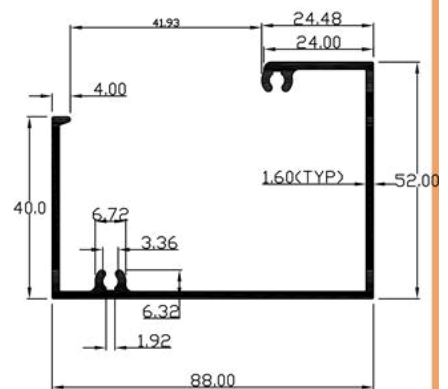

WEIGHT:- 5.114 kg/12'

CURTAIN WALL

NATIONAL INDUSTRIES

14231

SEC. NO:-14231

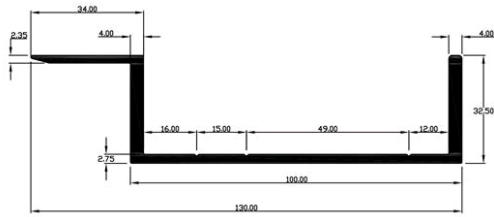

WEIGHT:- 6.900-7.200 kg/12'

CURTAIN WALL

14236

SEC. NO:-14236

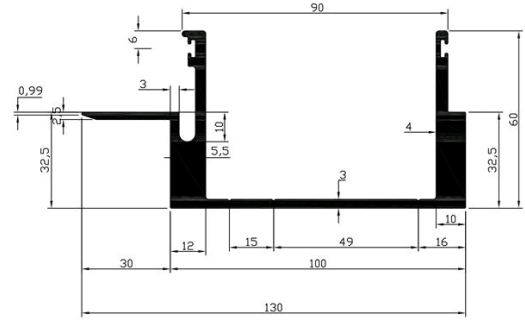

WEIGHT:- 4.800-5.100 kg/12'

CURTAIN WALL

14241

SEC. NO:-14241

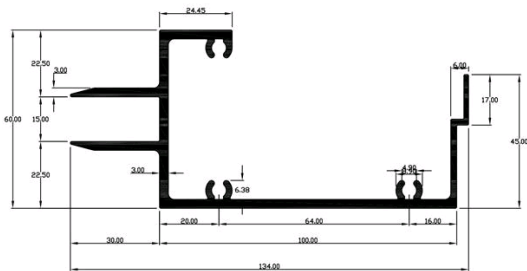

WEIGHT:- 6.900-7.200 kg/12'

CURTAIN WALL

14246

SEC. NO:-14246

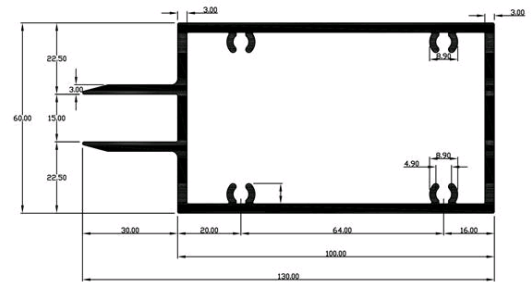

WEIGHT:- 4.800-5.100 kg/12'

CURTAIN WALL

NATIONAL INDUSTRIES

14251

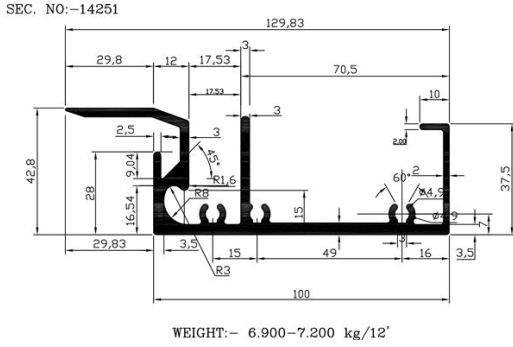

CURTAIN WALL

14256

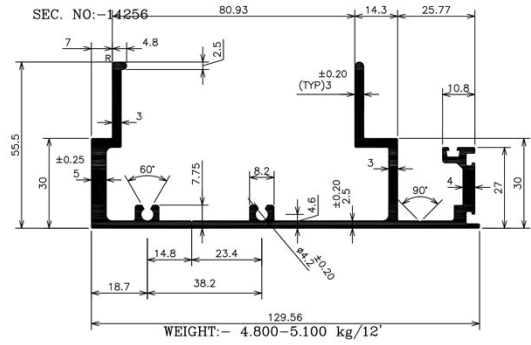

CURTAIN WALL

14261

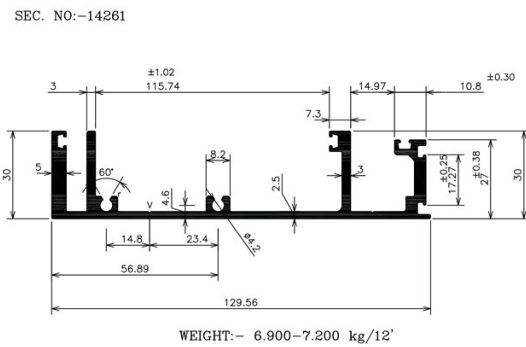

CURTAIN WALL

14266

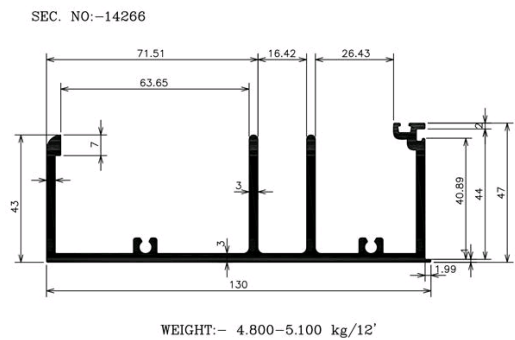

CURTAIN WALL

NATIONAL INDUSTRIES

14756

SEC. NO:-14756

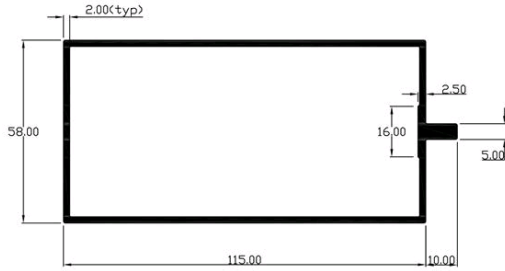

WEIGHT:- 7.253 kg/12'

CURTAIN WALL

14761

SEC. NO:-14761

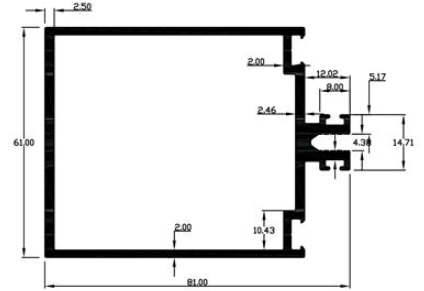

WEIGHT:- 6.524 kg/12'

CURTAIN WALL

14766

SEC. NO:-14766

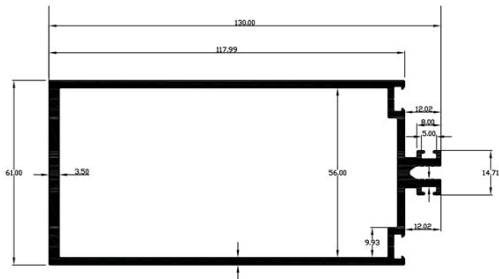

WEIGHT:- 10.100 kg/12'

CURTAIN WALL

14771

SEC. NO:-14771

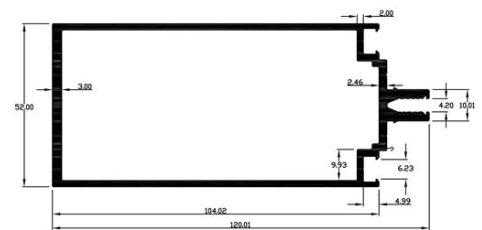

WEIGHT:- 7.711 kg/12'

CURTAIN WALL

NATIONAL INDUSTRIES

14776

SEC. NO:-14776

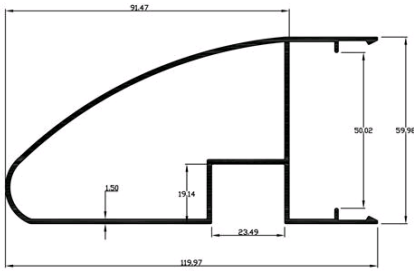

WEIGHT:- 5.040 kg/12'

CURTAIN WALL

14836

SEC. NO:-14836

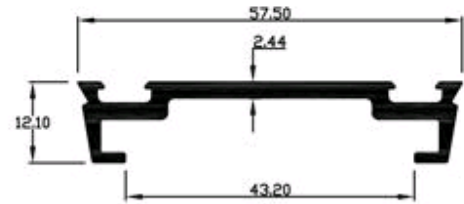

WEIGHT:- 2.030 kg/12'

CURTAIN WALL

14841

SEC. NO:-14841

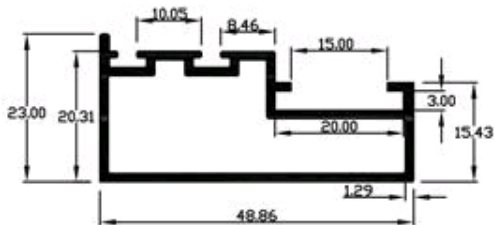

WEIGHT:- 2.035 kg/12'

CURTAIN WALL

14931

SEC. NO:-14931

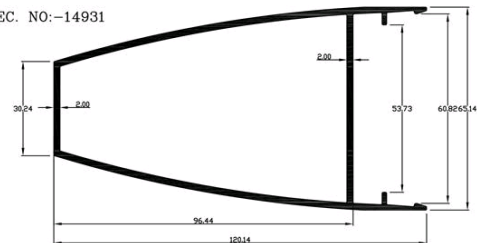

WEIGHT:- 6.510 kg/12'

CURTAIN WALL

NATIONAL INDUSTRIES

14936

SEC. NO:-14936

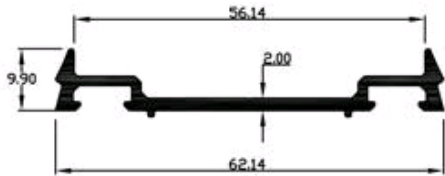

WEIGHT:- 1.612 kg/12'

CURTAIN WALL

14941

SEC. NO:-14941

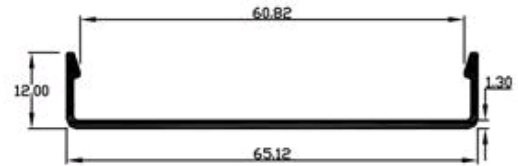

WEIGHT:- 1.100 kg/12'

CURTAIN WALL

15086

SEC. NO:-15086

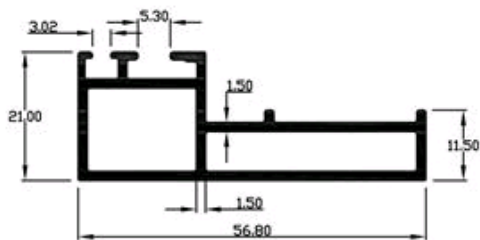

WEIGHT:- 2.520 kg/12'

CURTAIN WALL

15101

SEC. NO:-15101

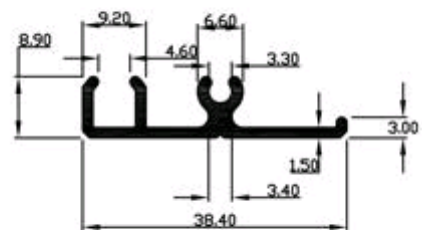

WEIGHT:- 1.077 kg/12'

CURTAIN WALL

NATIONAL INDUSTRIES

15106

SEC. NO:-15106

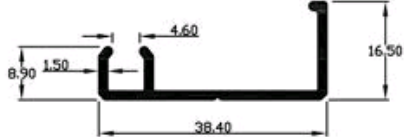

WEIGHT:- 1.022 kg/12'

CURTAIN WALL

15111

SEC. NO:-15111

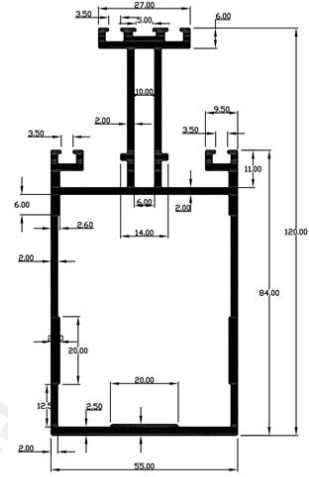

WEIGHT:- 9.356 kg/12'

CURTAIN WALL

15116

SEC. NO:-15116

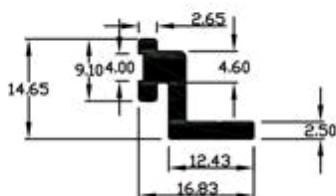

WEIGHT:- 0.850 kg/12'

CURTAIN WALL

15476

SEC. NO:-15476

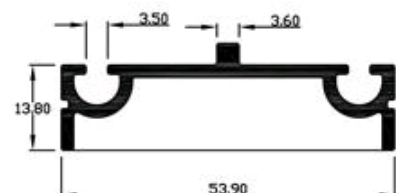

WEIGHT:- 1.950 kg/12'

CURTAIN WALL

NATIONAL INDUSTRIES

15481

SEC. NO:-15481

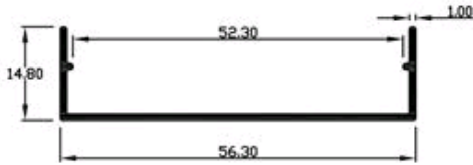

WEIGHT:- 0.850 kg/12'

CURTAIN WALL

15646

SEC. NO:-15646

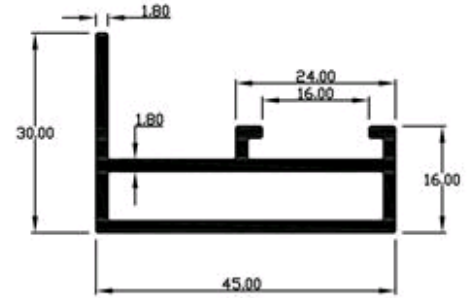

WEIGHT:- 2.458 kg/12'

CURTAIN WALL

16050

SEC. NO:-16050

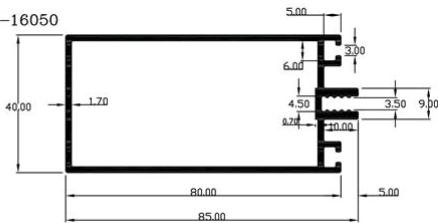

WEIGHT:- 4.640 kg/12'

CURTAIN WALL

16217

SEC. NO:-16217

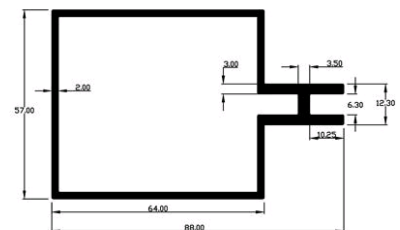

WEIGHT:- 6.141 kg/12'

CURTAIN WALL

NATIONAL INDUSTRIES

16218

SEC. NO:-16218

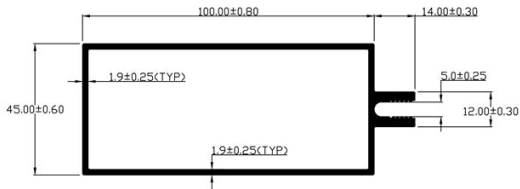

WEIGHT:- 6.248 kg/12'

CURTAIN WALL

16221

SEC. NO:-16221

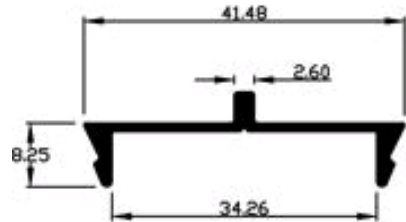

WEIGHT:- 0.844 kg/12'

CURTAIN WALL

16223

SEC. NO:-16223

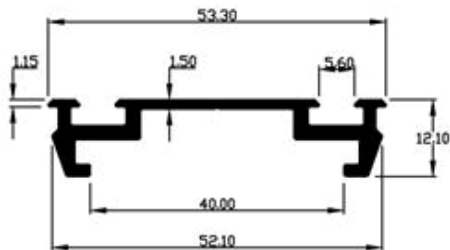

WEIGHT:- 1.750 kg/12'

CURTAIN WALL

16238

SEC. NO:-16238

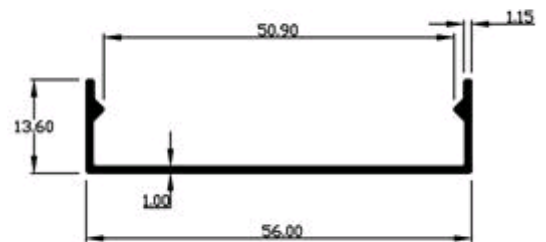

WEIGHT:- 0.866 kg/12'

CURTAIN WALL

NATIONAL INDUSTRIES

16246

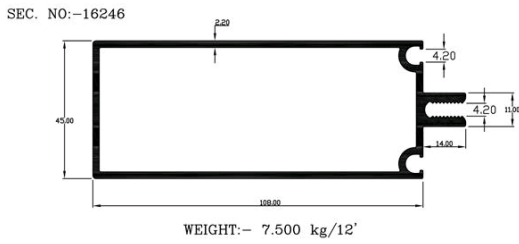

CURTAIN WALL

16247

SEC. NO:-16247

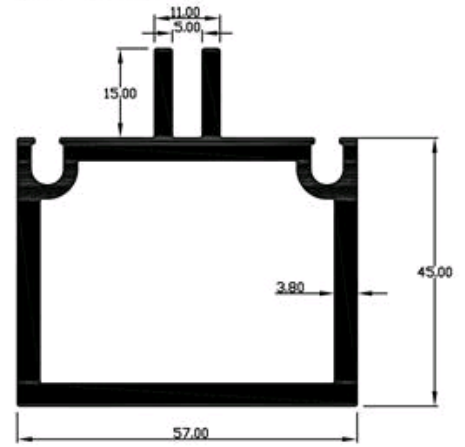

CURTAIN WALL

16248

SEC. NO:-16248

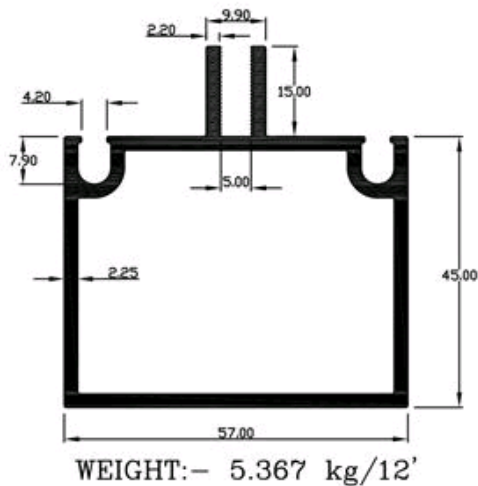

CURTAIN WALL

16288

SEC. NO:-16288

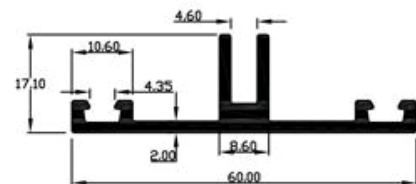

CURTAIN WALL

NATIONAL INDUSTRIES

16289

SEC. NO:-16289

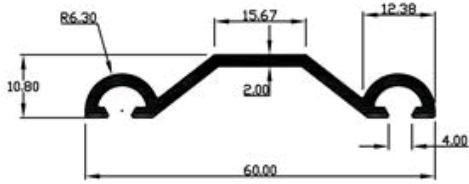

WEIGHT:- 1.686 kg/12'

CURTAIN WALL

16326

SEC. NO:-16326

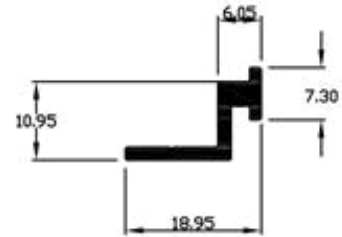

WEIGHT:- 0.630 kg/12'

CURTAIN WALL

16568

SEC. NO:-16568

IND-112

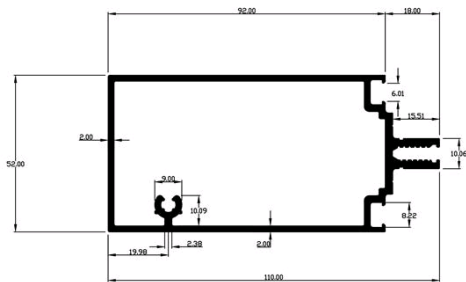

WEIGHT:- 7.240 kg/12'

CURTAIN WALL

16569

SEC. NO:-16569

IND-102

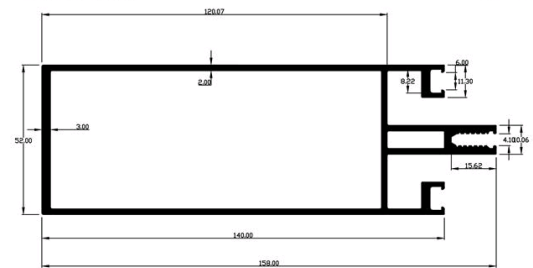

WEIGHT:- 10.500 kg/12'

CURTAIN WALL

NATIONAL INDUSTRIES

16570

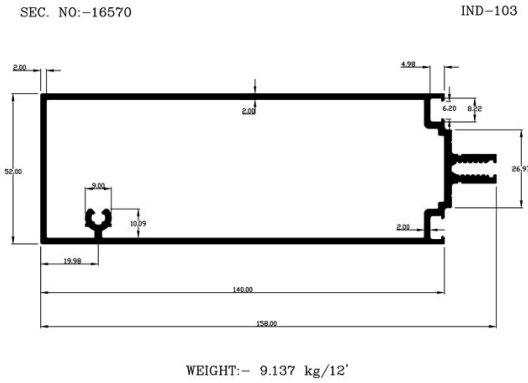

CURTAIN WALL

16571

SEC. NO:-16571

IND-104

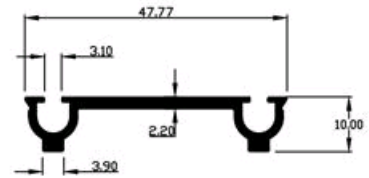

WEIGHT:- 1.403 kg/12'

CURTAIN WALL

16572

SEC. NO:-16572

IND-105

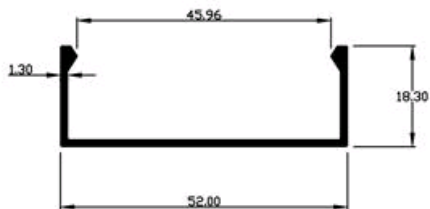

WEIGHT:- 1.200 kg/12'

CURTAIN WALL

16591

SEC. NO:-16591

IND

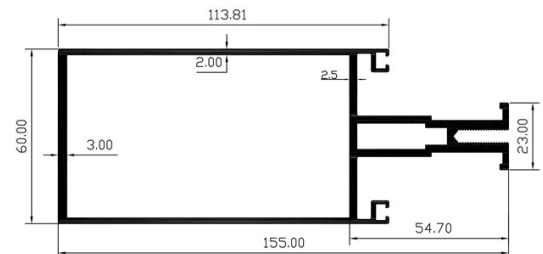

WEIGHT:- 11.065 kg/12'

CURTAIN WALL

NATIONAL INDUSTRIES

16592

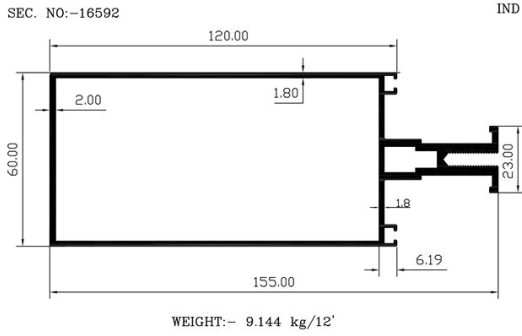

CURTAIN WALL

16643

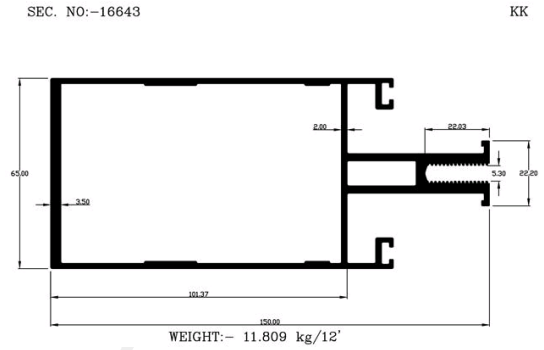

CURTAIN WALL

16644

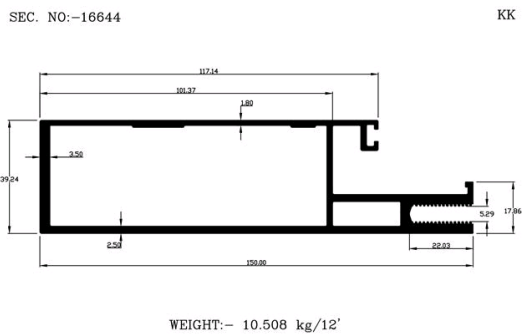

CURTAIN WALL

16706

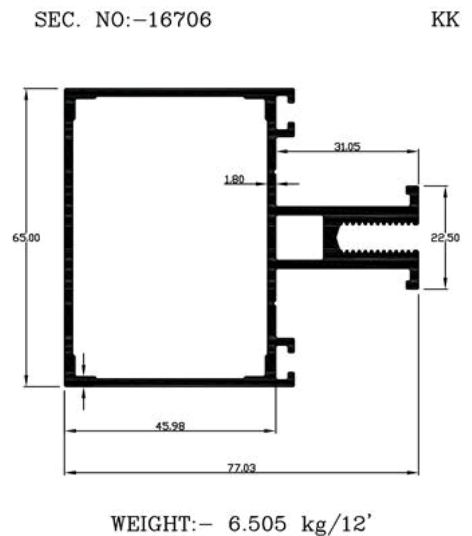

CURTAIN WALL

NATIONAL INDUSTRIES

16707

SEC. NO:-16707

KK



WEIGHT:- 2.895 kg/12'

CURTAIN WALL

16708

SEC. NO:-16708

KK

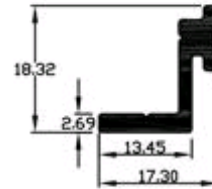

WEIGHT:- 0.863 kg/12'

CURTAIN WALL

16746

SEC. NO:-16746

AF

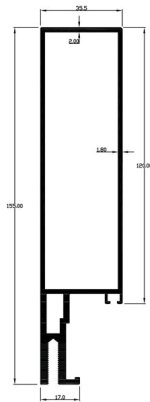

WEIGHT:- 7.963 kg/12'

CURTAIN WALL

16747

SEC. NO:-16747

AF

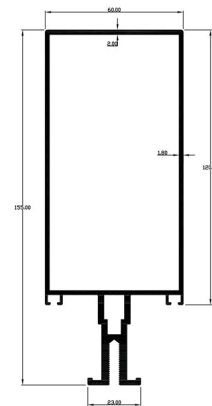

WEIGHT:- 9.158 kg/12'

CURTAIN WALL

NATIONAL INDUSTRIES

16748

SEC. NO:--16748

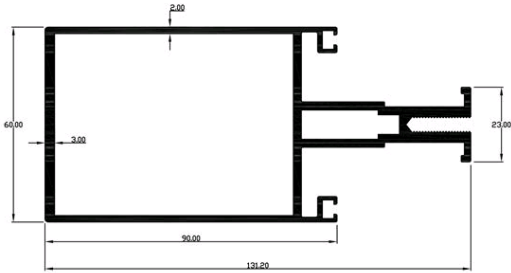

WEIGHT:- 10.136 kg/12'

CURTAIN WALL

16749

SEC. NO:--16749

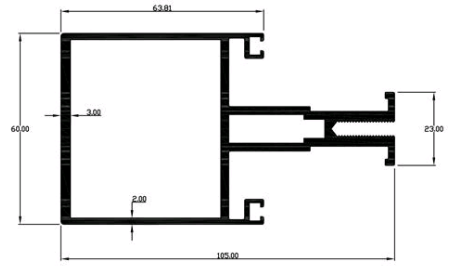

WEIGHT:- 9.101 kg/12'

CURTAIN WALL

16750

SEC. NO:--16750

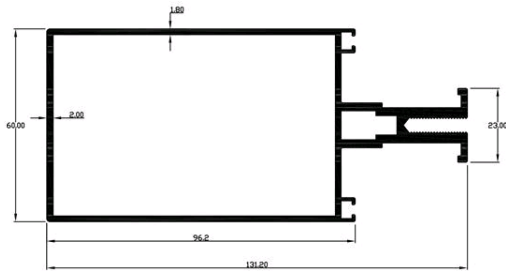

WEIGHT:- 8.311 kg/12'

CURTAIN WALL

16751

SEC. NO:--16751

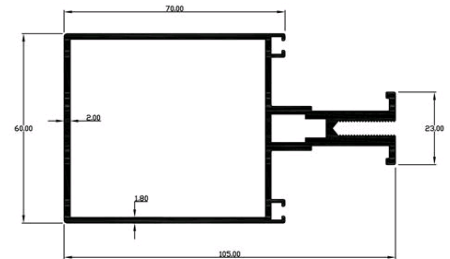

WEIGHT:- 7.380 kg/12'

CURTAIN WALL

NATIONAL INDUSTRIES

16752

SEC. NO:-16752

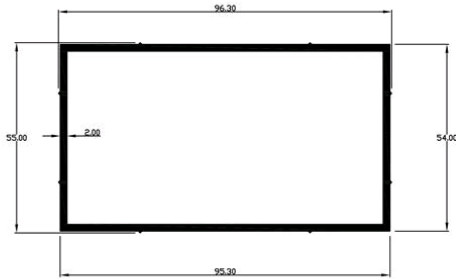

WEIGHT:- 5.765 kg/12'

CURTAIN WALL

16753

SEC. NO:-16753

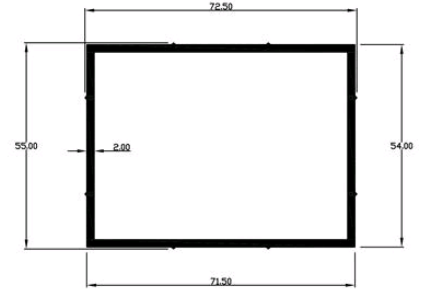

WEIGHT:- 4.824 kg/12'

CURTAIN WALL

16754

SEC. NO:-16754

AF

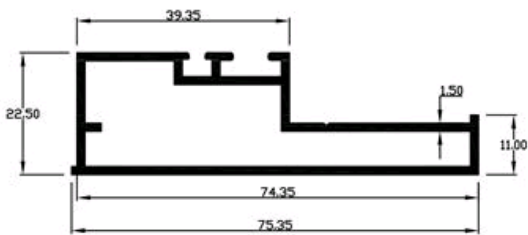

WEIGHT:- 3.085 kg/12'

CURTAIN WALL

16755

SEC. NO:-16755

AF

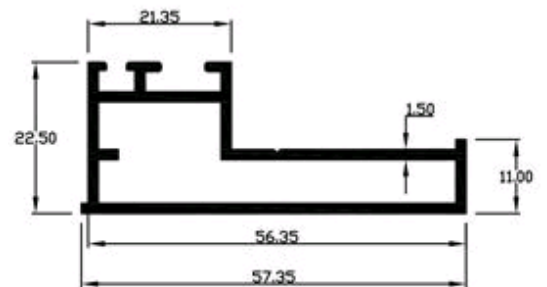

WEIGHT:- 2.486 kg/12'

CURTAIN WALL

NATIONAL INDUSTRIES

16756

SEC. NO:-16756

AF

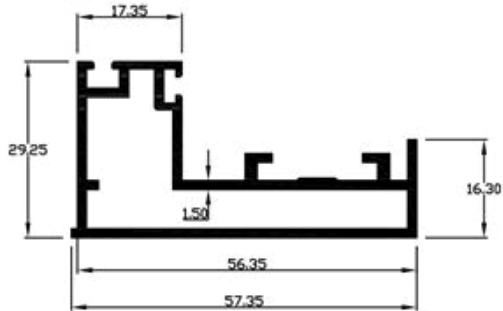

WEIGHT:- 3.000 kg/12'

CURTAIN WALL

16757

SEC. NO:-16757

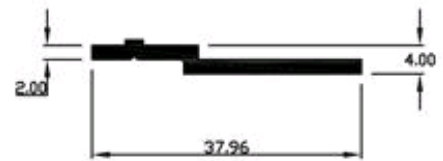

WEIGHT:- 0.806 kg/12'

CURTAIN WALL

16758

SEC. NO:-16758

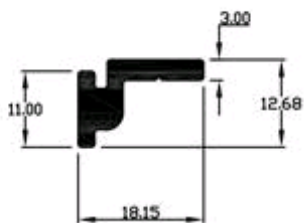

WEIGHT:- 0.927 kg/12'

CURTAIN WALL

16766

SEC. NO:-16766

N-623

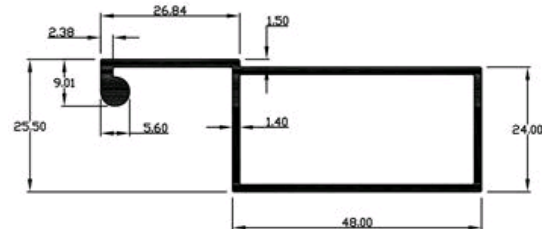

WEIGHT:- 2.618 kg/12'

CURTAIN WALL

NATIONAL INDUSTRIES

16767

SEC. NO:-16767

N-613

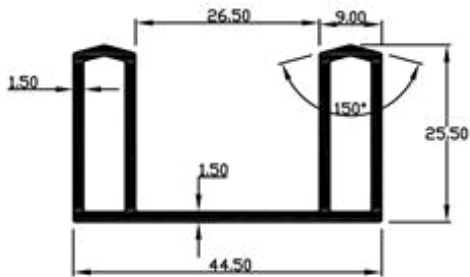

WEIGHT:- 3.516 kg/12'

CURTAIN WALL

16768

SEC. NO:-16768

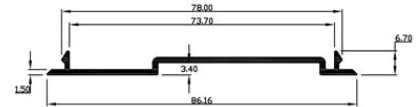

WEIGHT:- 1.498 kg/12'

CURTAIN WALL

16769

SEC. NO:-16769

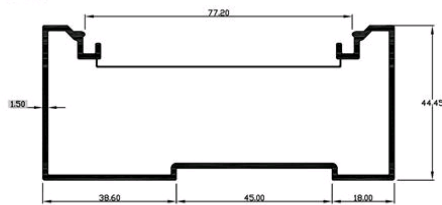

WEIGHT:- 3.883 kg/12'

CURTAIN WALL

16801

SEC. NO:-16801

N-646

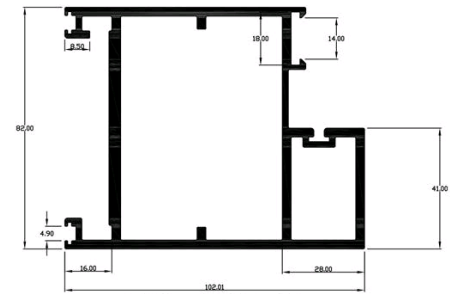

WEIGHT:- 13.179 kg/12'

CURTAIN WALL

NATIONAL INDUSTRIES

16802

SEC. NO:-16802

IND-190

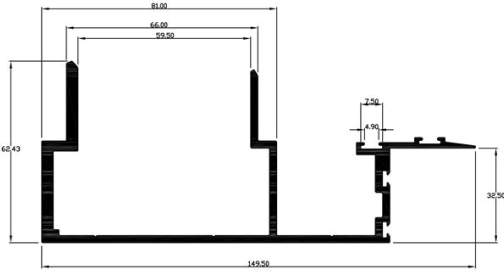

WEIGHT:- 9.012 kg/12'

CURTAIN WALL

16803

SEC. NO:-16803

IND-191

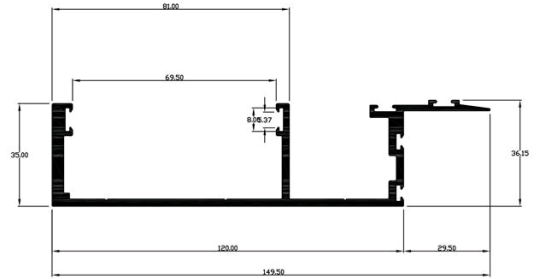

WEIGHT:- 7.112 kg/12'

CURTAIN WALL

16804

SEC. NO:-16804

IND-192

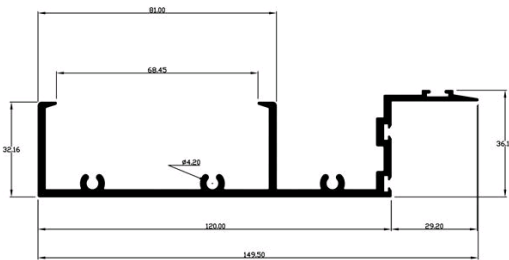

WEIGHT:- 6.696 kg/12'

CURTAIN WALL

16805

SEC. NO:-16805

IND-194

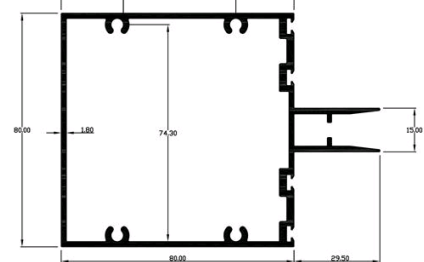

WEIGHT:- 8.250 kg/12'

CURTAIN WALL

NATIONAL INDUSTRIES

16806

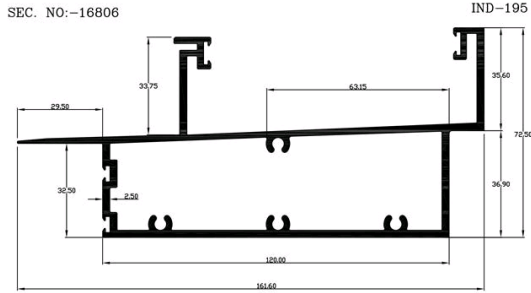

WEIGHT:- 11.379 kg/12'

CURTAIN WALL

16807

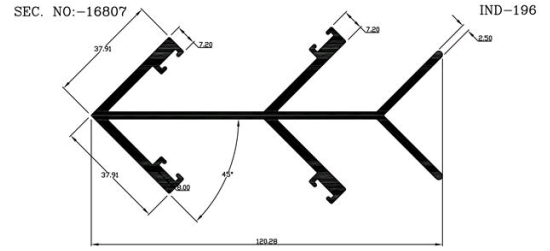

WEIGHT:- 9.130 kg/12'

CURTAIN WALL

16808

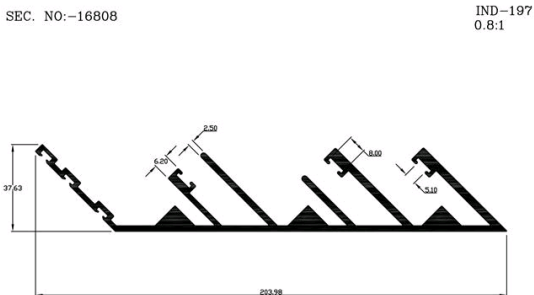

WEIGHT:- 13.724 kg/12'

CURTAIN WALL

16812

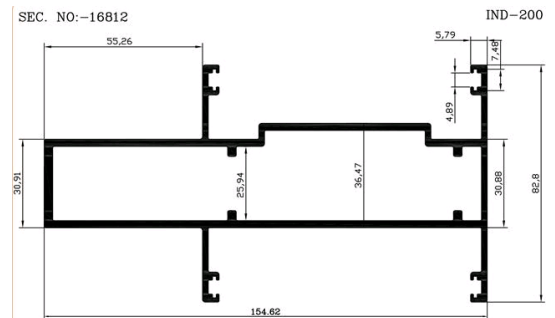

WEIGHT:- 12.230 kg/12'

CURTAIN WALL

NATIONAL INDUSTRIES

16813

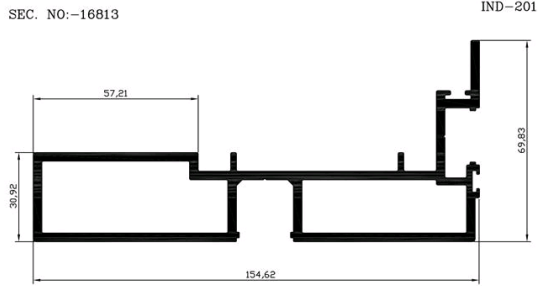

WEIGHT:- 13.346 kg/12'

CURTAIN WALL

16814

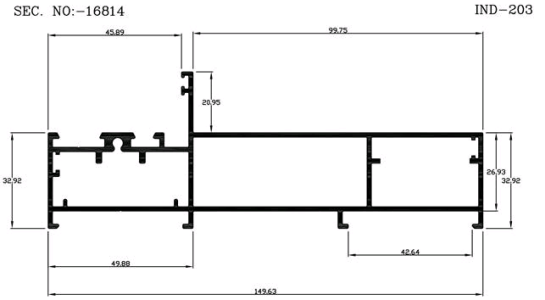

WEIGHT:- 7.606 kg/12'

CURTAIN WALL

16815

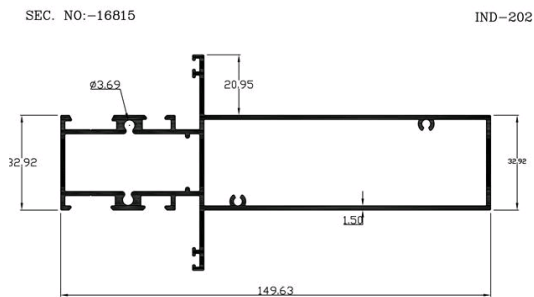

WEIGHT:- 7.753 kg/12'

CURTAIN WALL

16818

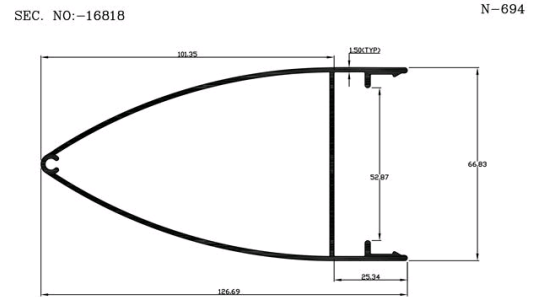

WEIGHT:- 5.358 kg/12'

CURTAIN WALL

NATIONAL INDUSTRIES

16819

SEC. NO:-16819

N-695

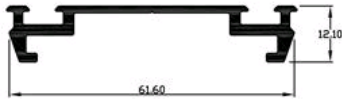

WEIGHT:- 1.891 kg/12'

CURTAIN WALL

16829

SEC. NO:-16829

IND-193

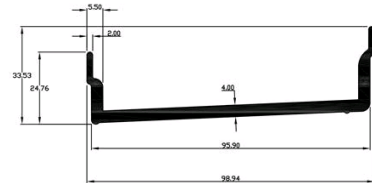

WEIGHT:- 5.223 kg/12'

CURTAIN WALL

16834

SEC. NO:-16834

N-684

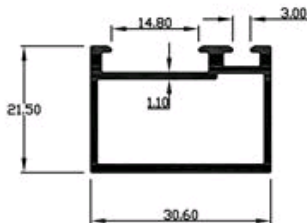

WEIGHT:- 1.380 kg/12'

CURTAIN WALL

16839

SEC. NO:-16839

N-654

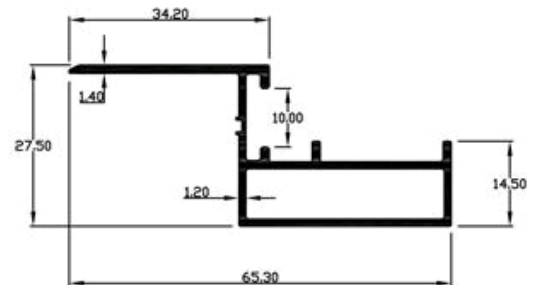

WEIGHT:- 1.887 kg/12'

CURTAIN WALL

NATIONAL INDUSTRIES

16840

SEC. NO:-16840

N-655

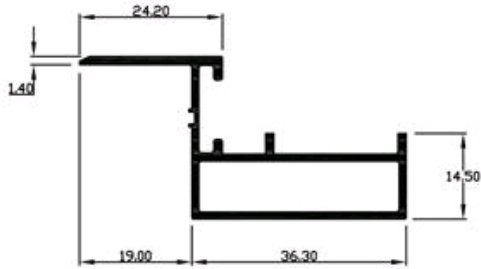

WEIGHT:- 1.749 kg/12'

CURTAIN WALL

16841

SEC. NO:-16841

IND-185

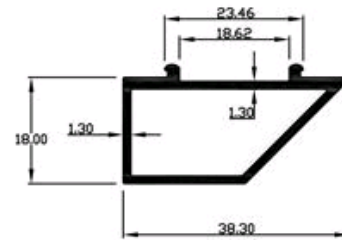

WEIGHT:- 1.430 kg/12'

CURTAIN WALL

16842

SEC. NO:-16842

IND-186

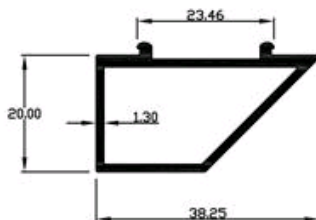

WEIGHT:- 1.467 kg/12'

CURTAIN WALL

16844

SEC. NO:-16844

IND-189

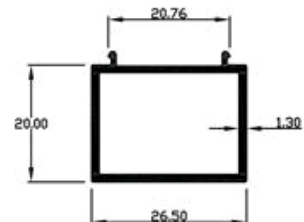

WEIGHT:- 1.133 kg/12'

CURTAIN WALL