

NATIONAL INDUSTRIES

12736

SEC. NO:- 12736

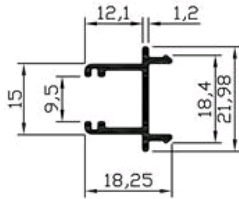

AREA:- 72.796 Sqmm[^]
WEIGHT:- 0.719 kg/12'

DUMBHAL (W)

12741

SEC. NO:- 12741

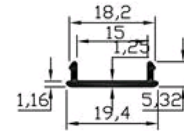

AREA:- 33.300 Sqmm[^]
WEIGHT:- 0.329 kg/12'

DUMBHAL (W)

13001

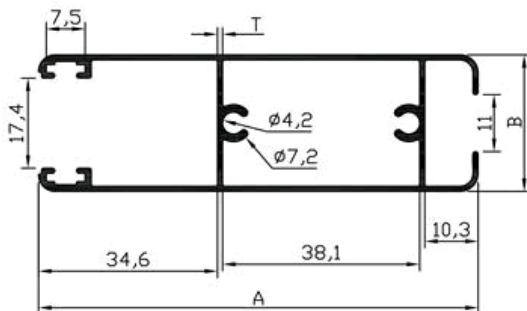

DUMBHAL (W)

13011

SEC. NO:- 13011

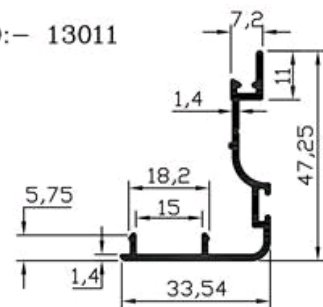

WEIGHT:- 1.450-1.550 kg/12'

DUMBHAL (W)

NATIONAL INDUSTRIES

14021

SEC. NO:-14021
SEC. NO:- P-09

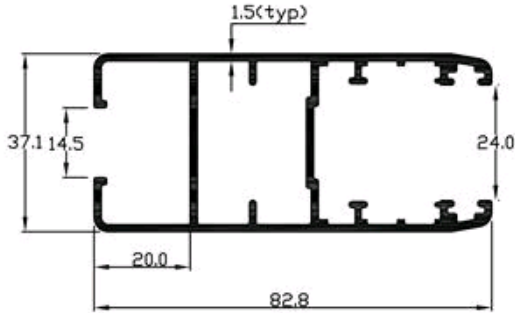

WEIGHT:- 4.500-4.800 kg/12'

DUMBHAL (W)

14031

SEC. NO:-14031
SEC. NO:- P-10

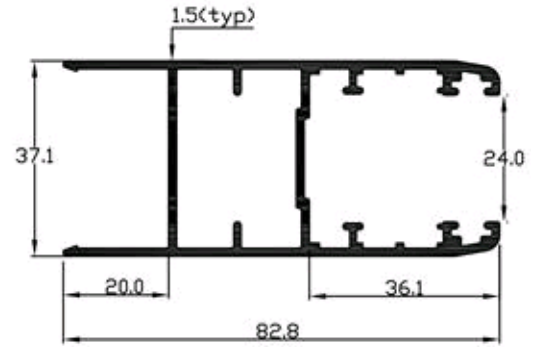

WEIGHT:- 4.200-4.500 kg/12'

DUMBHAL (W)

14036

SEC. NO:-14036
SEC. NO:- P-12

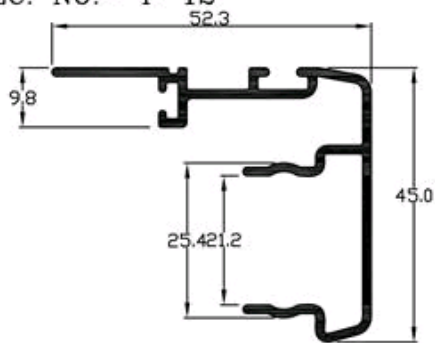

WEIGHT:- 2.200-2.400 kg/12'

DUMBHAL (W)

14041

SEC. NO:-14041
SEC. NO:- P-11

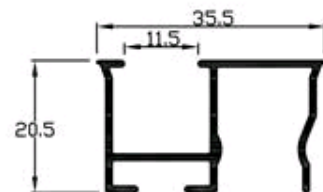

WEIGHT:- 0.900-1.200 kg/12'

DUMBHAL (W)

NATIONAL INDUSTRIES

14046

SEC. NO:-14046
SEC. NO:- P-08

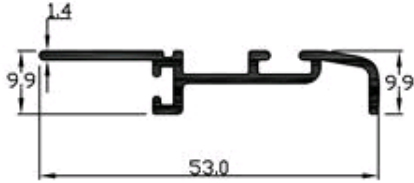

WEIGHT:- 1.100-1.300 kg/12'

DUMBHAL (W)

14056

SEC. NO:-14056
SEC. NO:- P-07

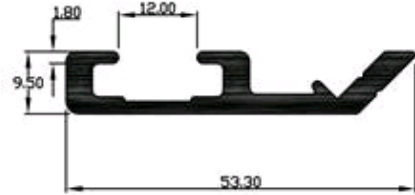

WEIGHT:- 2.100-2.400 kg/12'

DUMBHAL (W)

14061

SEC. NO:- P-13
SEC. NO:-14061

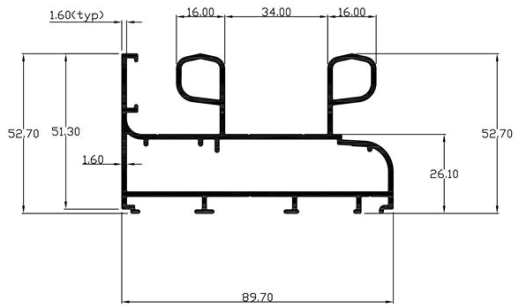

WEIGHT:- 6.400-6.700 kg/12'

DUMBHAL (W)

14066

SEC. NO:-14066
SEC. NO:- P-26

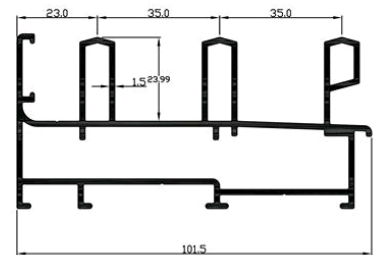

WEIGHT:- 6.900-7.200 kg/12'

DUMBHAL (W)

NATIONAL INDUSTRIES

14071

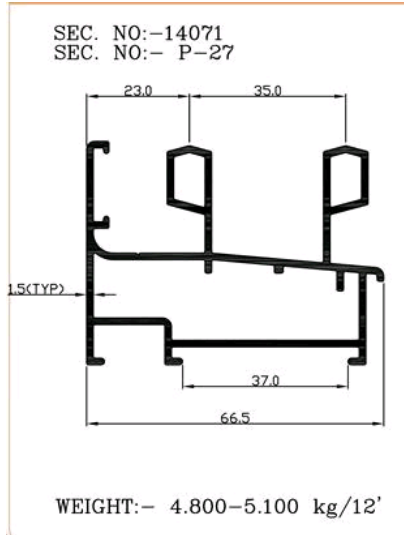

DUMBHAL (W)

14075

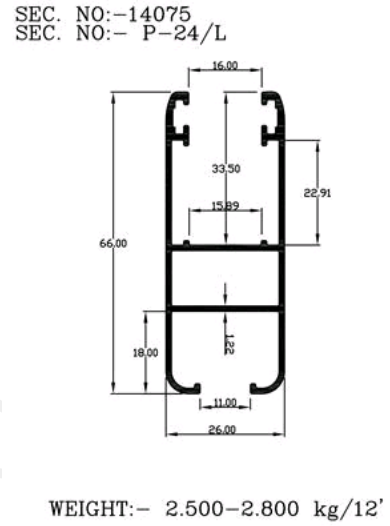

DUMBHAL (W)

14076

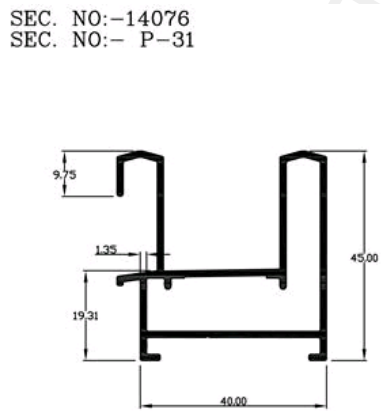

DUMBHAL (W)

14081

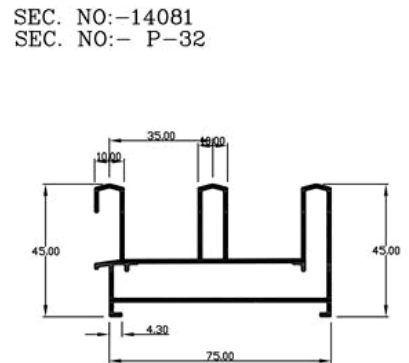

DUMBHAL (W)

NATIONAL INDUSTRIES

14086

SEC. NO:-14086
SEC. NO:- P-24

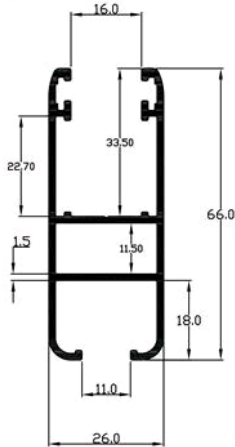

WEIGHT:- 3.000-3.300 kg/12'

DUMBHAL (W)

14091

SEC. NO:-14091
SEC. NO:- P-25

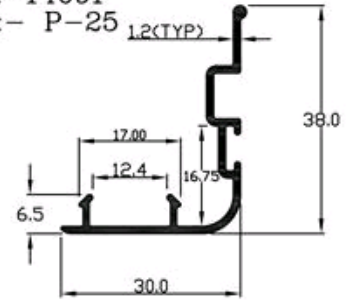

WEIGHT:- 0.950-1.200 kg/12'

DUMBHAL (W)

14096

SEC. NO:-14096

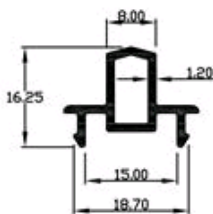

WEIGHT:- 0.700-1.000 kg/12'

DUMBHAL (W)

14101

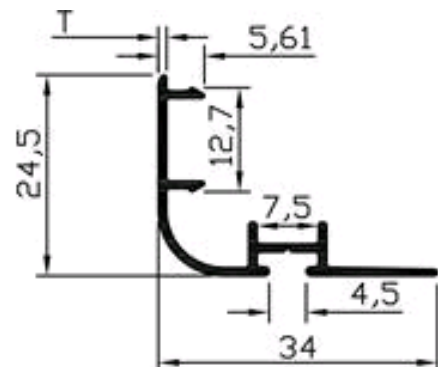

DUMBHAL (W)

NATIONAL INDUSTRIES

14111

SEC. NO:-14111

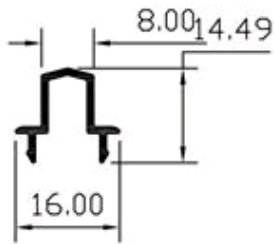

WEIGHT:- 0.400-0.600 kg/12'

DUMBHAL (W)

14116

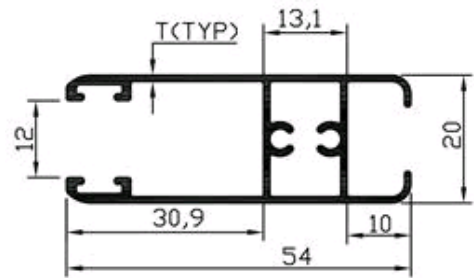

DUMBHAL (W)

14126

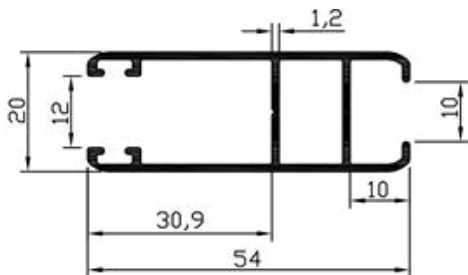

DUMBHAL (W)

14141

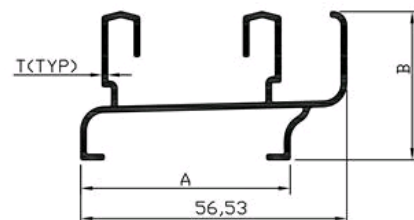

DUMBHAL (W)

NATIONAL INDUSTRIES

14151

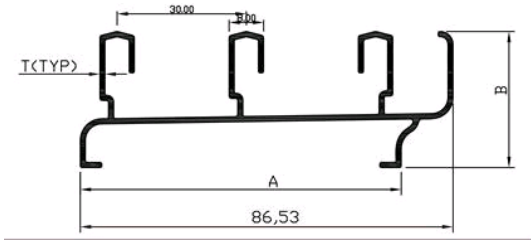

DUMBHAL (W)

14161

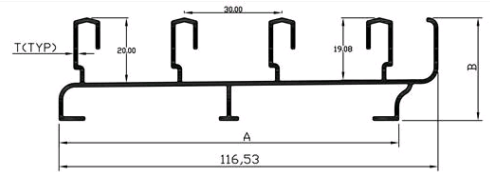

DUMBHAL (W)

14171

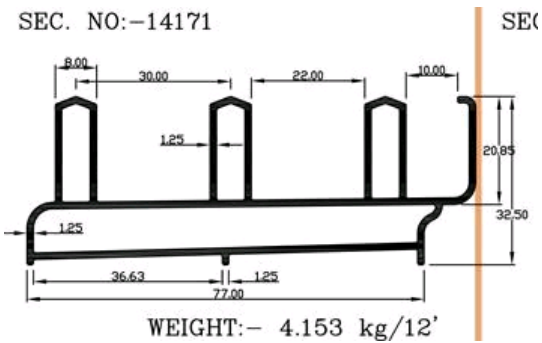

WEIGHT:- 4.153 kg/12'

DUMBHAL (W)

14176

EC. NO:-14176

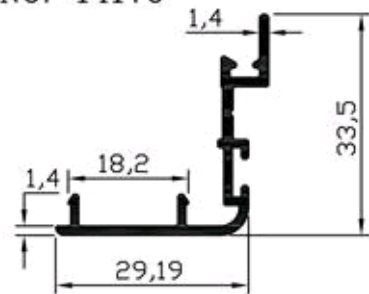

WEIGHT:- 1.190-1.250 kg/12'

DUMBHAL (W)

NATIONAL INDUSTRIES

14181

SEC. NO:-14181

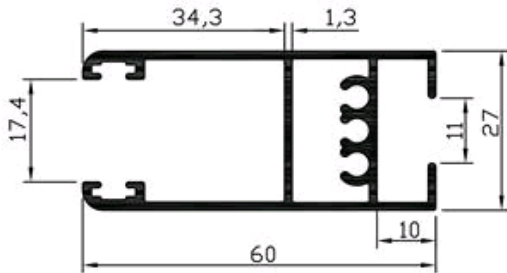

WEIGHT:- 3.090-3.200 kg/12'

DUMBHAL (W)

14186

SEC. NO:-14186

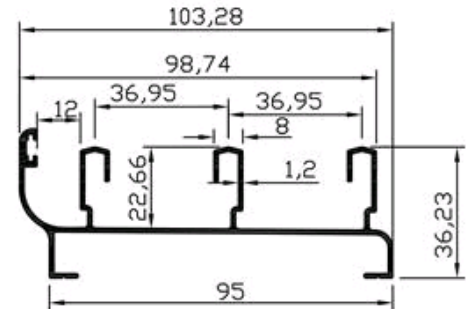

WEIGHT:- 3.500-3.800 kg/12'

DUMBHAL (W)

14191

SEC. NO:-14191

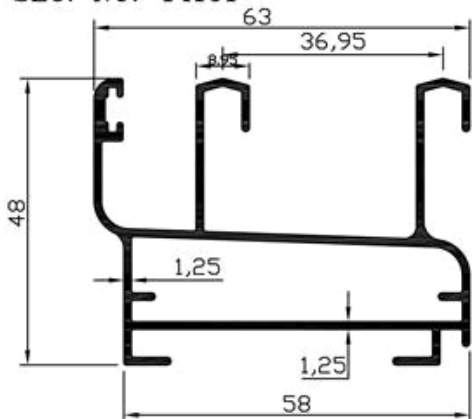

WEIGHT:- 3.7000-4.000 kg/12'

DUMBHAL (W)

14196

SEC. NO:-14196

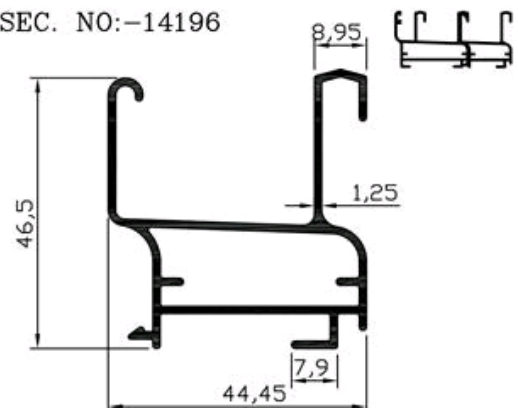

WEIGHT:- 2.600-2.700 kg/12'

DUMBHAL (W)

NATIONAL INDUSTRIES

14197

SEC. NO:-14197

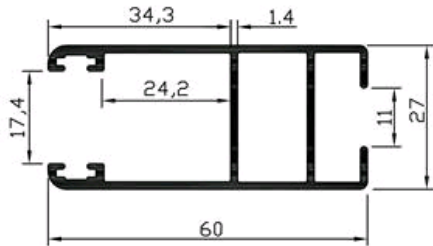

WEIGHT:- 3.000-3.200 kg/12'

DUMBHAL (W)

14201

SEC. NO:-14201

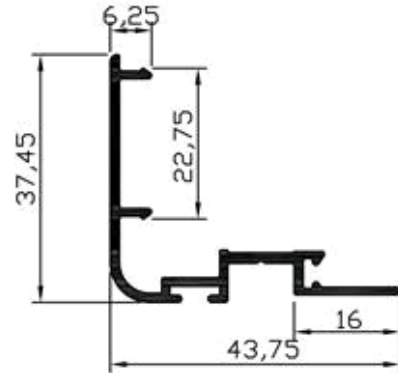

WEIGHT:- 1.400-1.520 kg/12'

DUMBHAL (W)

14206

SEC. NO:-14206

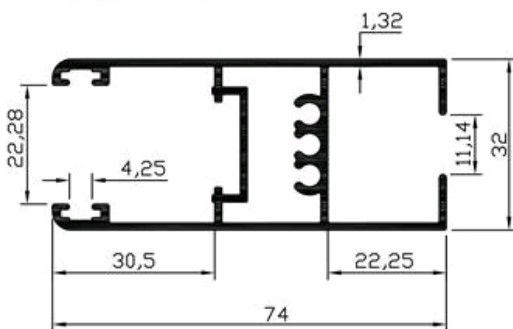

WEIGHT:- 3.800-4.100 kg/12'

DUMBHAL (W)

14211

SEC. NO:-14211

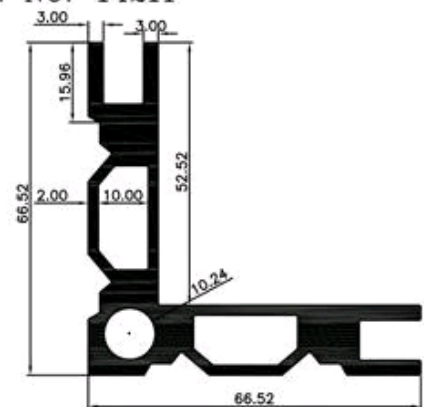

WEIGHT:- 8.600 kg/12'

DUMBHAL (W)

NATIONAL INDUSTRIES

14216

SEC. NO:-14216

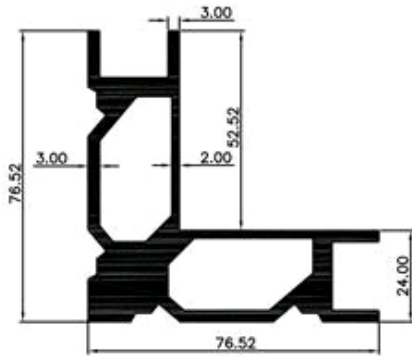

WEIGHT:- 12.400 kg/12'

DUMBHAL (W)

14701

SEC. NO:-14701

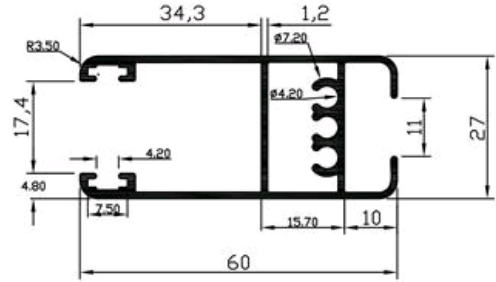

WEIGHT:- 2.871 kg/12'

DUMBHAL (W)

14706

SEC. NO:-14706

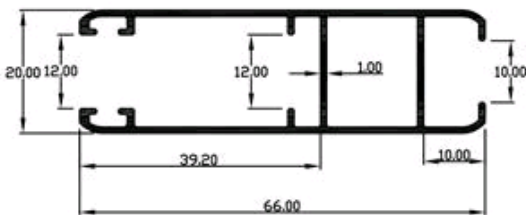

WEIGHT:- 1.954 kg/12'

DUMBHAL (W)

14711

SEC. NO:-14711

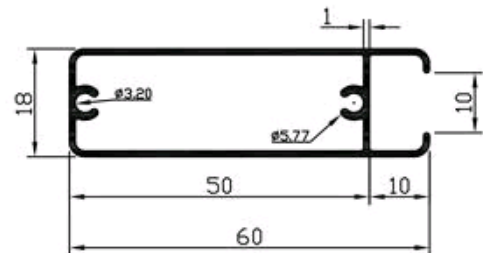

WEIGHT:- 1.700-1.900 kg/12'

DUMBHAL (W)

NATIONAL INDUSTRIES

14716

SEC. NO:-14716

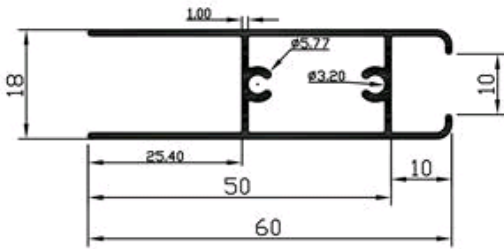

WEIGHT:- 1.750-2.000 kg/12'

DUMBHAL (W)

14791

SEC. NO:-14791

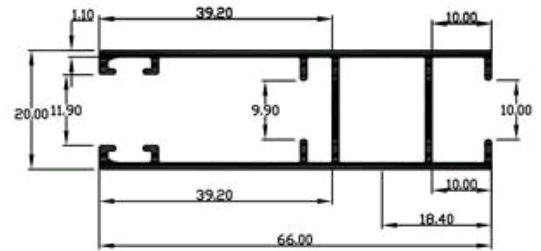

WEIGHT:- 2.196 kg/12'

DUMBHAL (W)

14976

SEC. NO:-14976

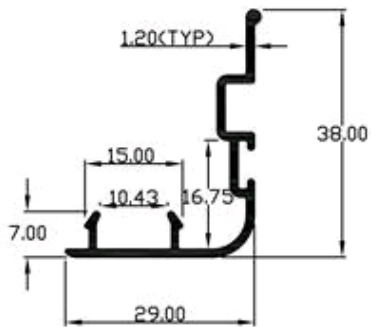

WEIGHT:- 1.042 kg/12'

DUMBHAL (W)

15026

SEC. NO:-15026

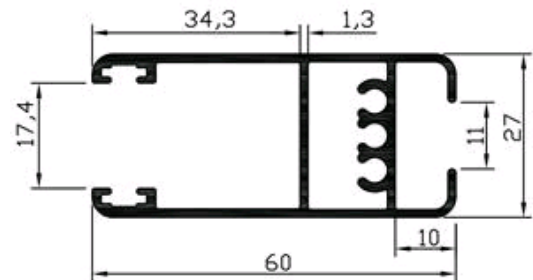

WEIGHT:- 3.059 kg/12'

DUMBHAL (W)

NATIONAL INDUSTRIES

15161

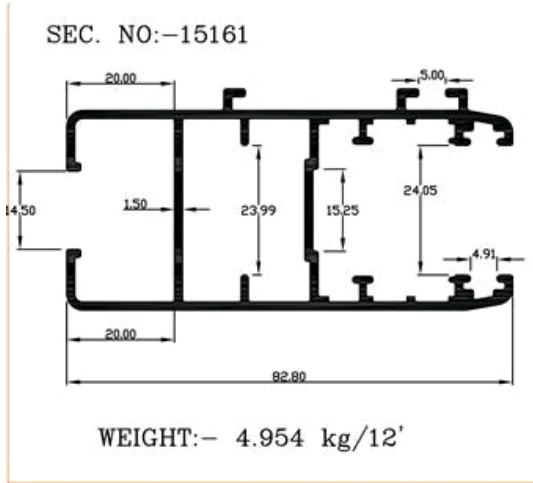

DUMBHAL (W)

15166

SEC. NO:-15166

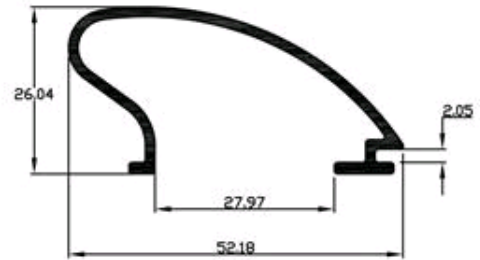

DUMBHAL (W)

15421

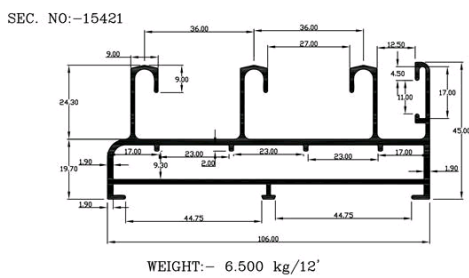

DUMBHAL (W)

15701

SEC. NO:-15701

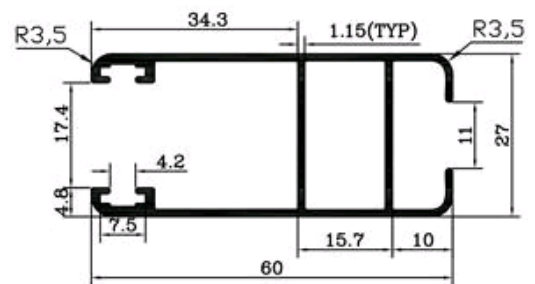

DUMBHAL (W)

NATIONAL INDUSTRIES

15706

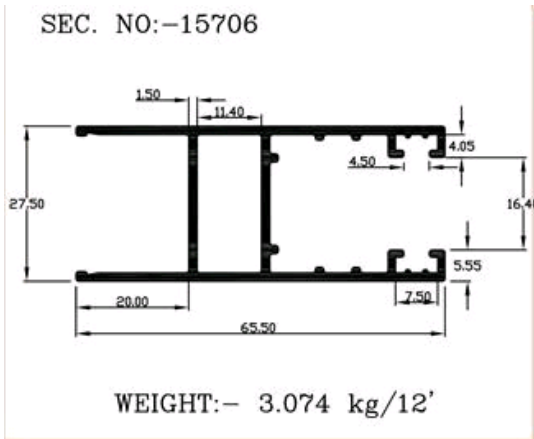

DUMBHAL (W)

15711

SEC. NO:-15711

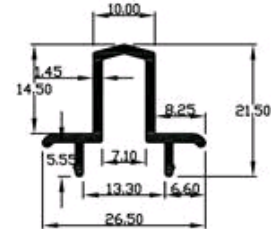

DUMBHAL (W)

15726

SEC. NO:-15726

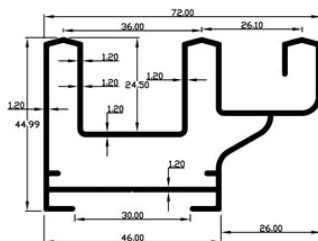

DUMBHAL (W)

15766

SEC. NO:-15766

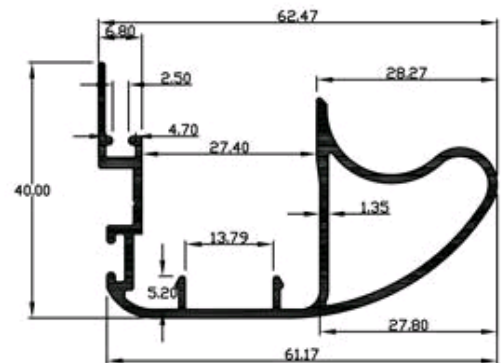

DUMBHAL (W)

NATIONAL INDUSTRIES

15771

SEC. NO:-15771

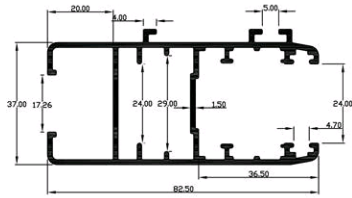

WEIGHT:- 4.953 kg/12'

DUMBHAL (W)

15776

SEC. NO:-15776

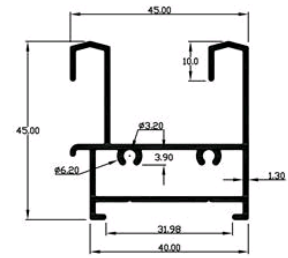

WEIGHT:- 2.900 kg/12'

DUMBHAL (W)

15781

SEC. NO:-15781

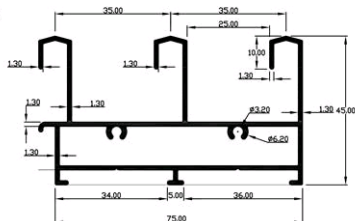

WEIGHT:- 4.427 kg/12'

DUMBHAL (W)

15786

SEC. NO:-15786

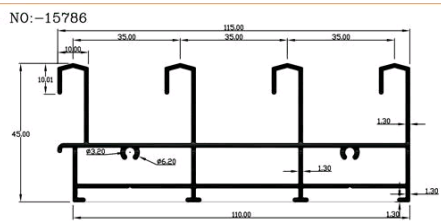

WEIGHT:- 6.262 kg/12'

DUMBHAL (W)

NATIONAL INDUSTRIES

15811

SEC. NO:-15811

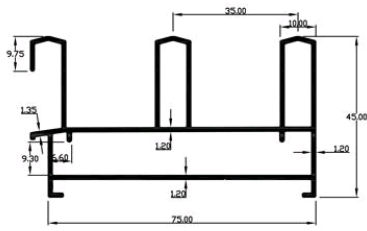

WEIGHT:- 4.233 kg/12'

DUMBHAL (W)

15923

SEC. NO:-15923

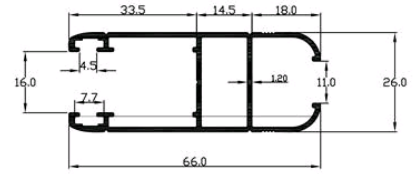

WEIGHT:- 2.533 kg/12'

DUMBHAL (W)

15935

SEC. NO:-15935

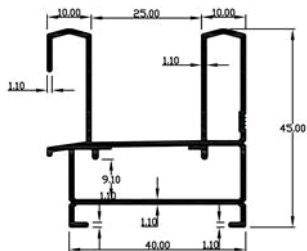

WEIGHT:- 2.550 kg/12'

DUMBHAL (W)

15936

SEC. NO:-15936

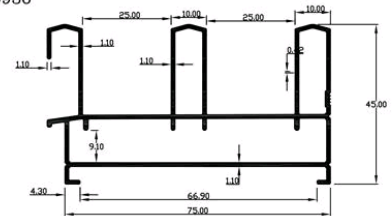

WEIGHT:- 3.988 kg/12'

DUMBHAL (W)

NATIONAL INDUSTRIES

16015

SEC. NO:-16015

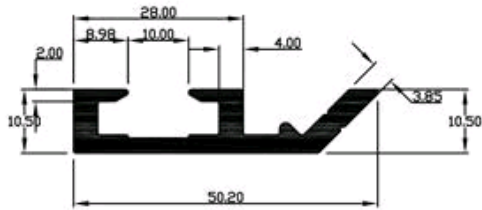

WEIGHT:- 2.400 kg/12'

DUMBHAL (W)

16016

SEC. NO:-16016

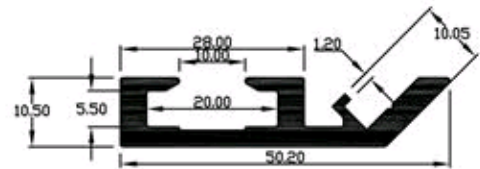

WEIGHT:- 2.440 kg/12'

DUMBHAL (W)

16017

SEC. NO:-16017

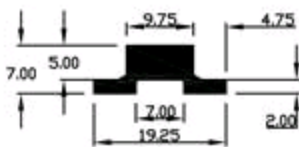

WEIGHT:- 0.716 kg/12'

DUMBHAL (W)

16018

SEC. NO:-16018

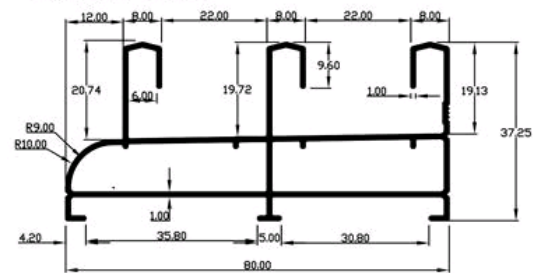

WEIGHT:- 3.161 kg/12'

DUMBHAL (W)

NATIONAL INDUSTRIES

16019

SEC. NO:-16019

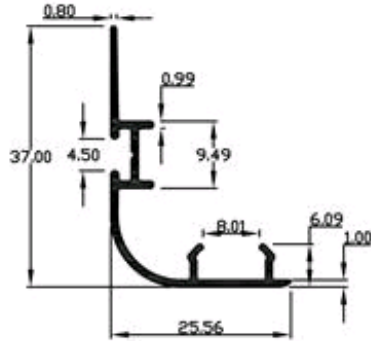

WEIGHT:- 0.778 kg/12'

DUMBHAL (W)

16020

SEC. NO:-16020

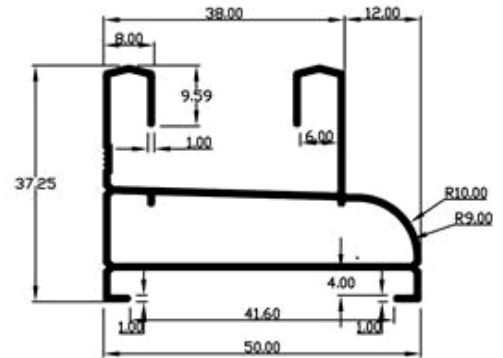

WEIGHT:- 2.012 kg/12'

DUMBHAL (W)

16021

SEC. NO:-16021

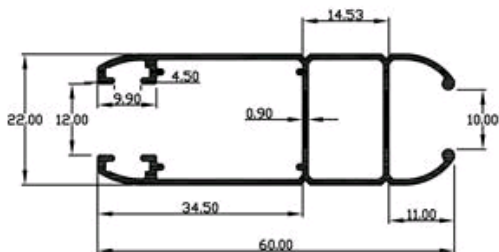

WEIGHT:- 1.773 kg/12'

DUMBHAL (W)

16022

SEC. NO:-16022

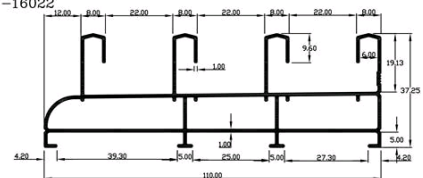

WEIGHT:- 4.313 kg/12'

DUMBHAL (W)

NATIONAL INDUSTRIES

16023

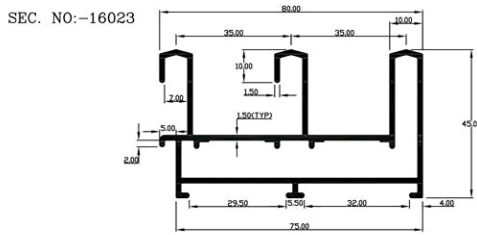

WEIGHT:- 5.138 kg/12'

DUMBHAL (W)

16024

SEC. NO:-16024

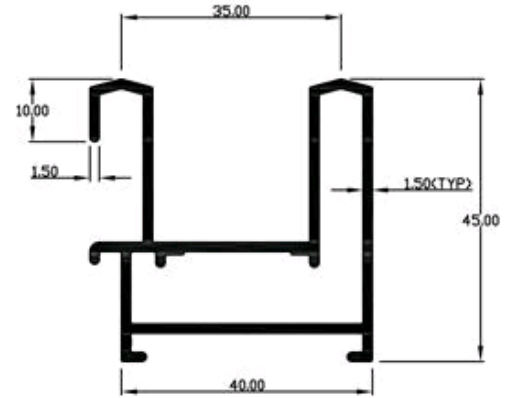

WEIGHT:- 3.273 kg/12'

DUMBHAL (W)

16025

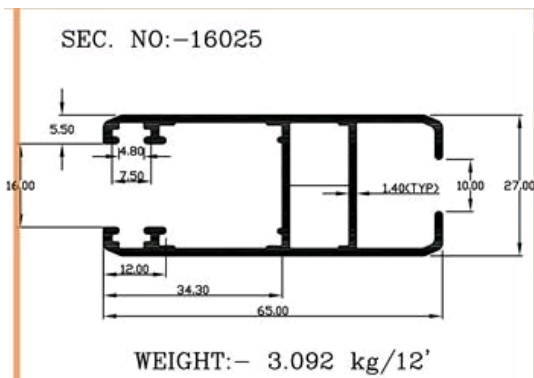

WEIGHT:- 3.092 kg/12'

DUMBHAL (W)

16026

SEC. NO:-16026

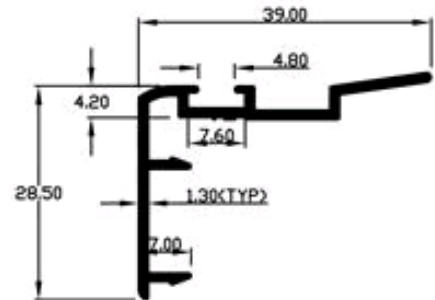

WEIGHT:- 1.100 kg/12'

DUMBHAL (W)

NATIONAL INDUSTRIES

16040

SEC. NO:-16040

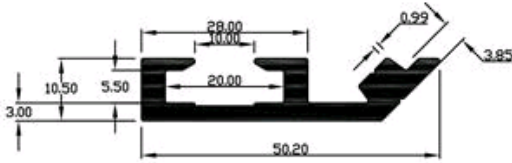

WEIGHT:- 2.5395 kg/12'

DUMBHAL (W)

16046

SEC. NO:-16046

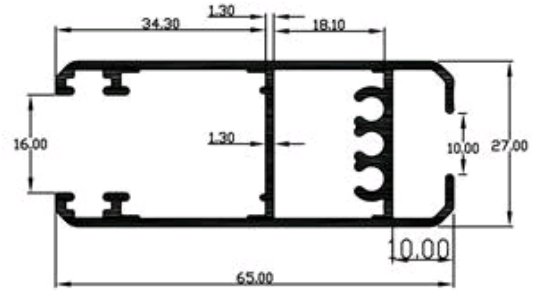

WEIGHT:- 3.286 kg/12'

DUMBHAL (W)

16089

SEC. NO:-16089

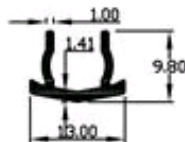

WEIGHT:- 0.350 kg/12'

DUMBHAL (W)

16090

SEC. NO:-16090

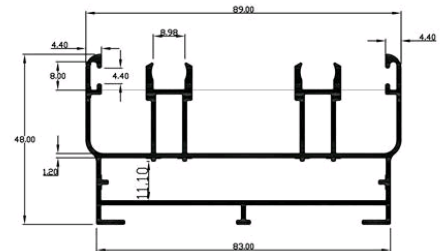

WEIGHT:- 5.440 kg/12'

DUMBHAL (W)

NATIONAL INDUSTRIES

16091

SEC. NO:-16091

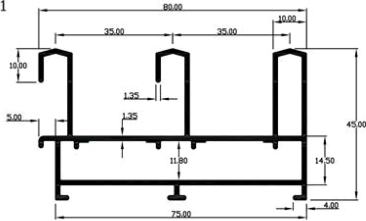

WEIGHT:- 4.750 kg/12'

DUMBHAL (W)

16092

SEC. NO:-16092

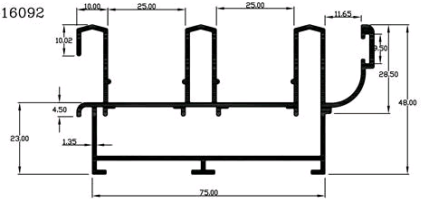

WEIGHT:- 5.688 kg/12'

DUMBHAL (W)

16093

SEC. NO:-16093

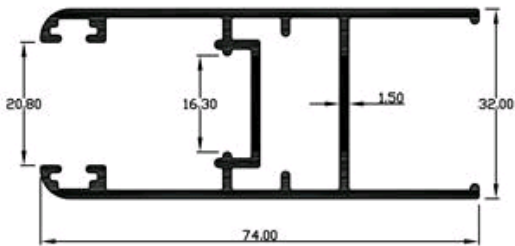

WEIGHT:- 3.536 kg/12'

DUMBHAL (W)

16094

SEC. NO:-16094

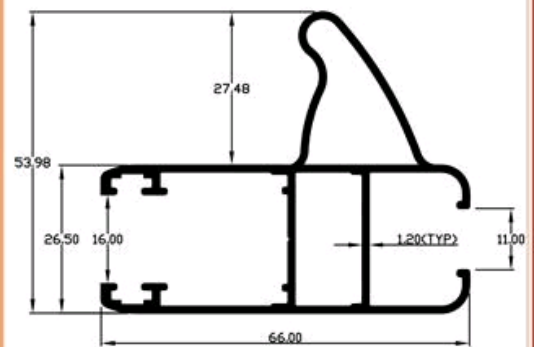

WEIGHT:- 3.460 kg/12'

DUMBHAL (W)

NATIONAL INDUSTRIES

16095

SEC. NO:-16095

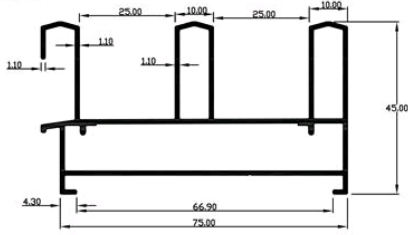

WEIGHT:- 4.000 kg/12'

DUMBHAL (W)

16096

SEC. NO:-16096

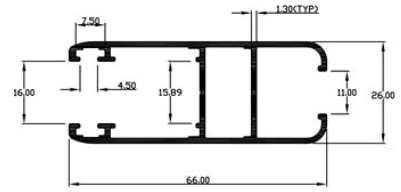

WEIGHT:- 2.800 kg/12'

DUMBHAL (W)

16097

SEC. NO:-16097

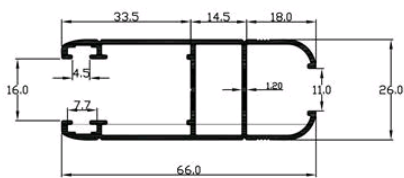

WEIGHT:- 2.500 kg/12'

DUMBHAL (W)

16123

SEC. NO:-16123

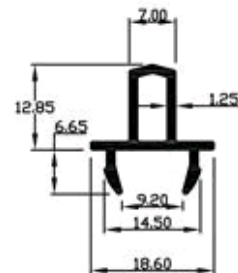

WEIGHT:- 0.737 kg/12'

DUMBHAL (W)

NATIONAL INDUSTRIES

16124

SEC. NO:-16124

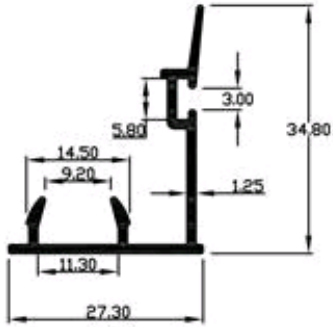

WEIGHT:- 1.000 kg/12'

DUMBHAL (W)

16125

SEC. NO:-16125

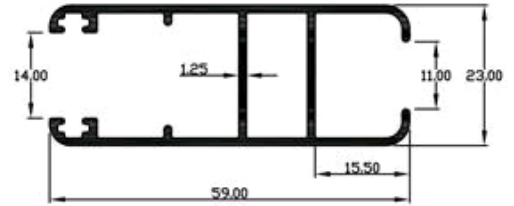

WEIGHT:- 2.000 kg/12'

DUMBHAL (W)

16126

SEC. NO:-16126

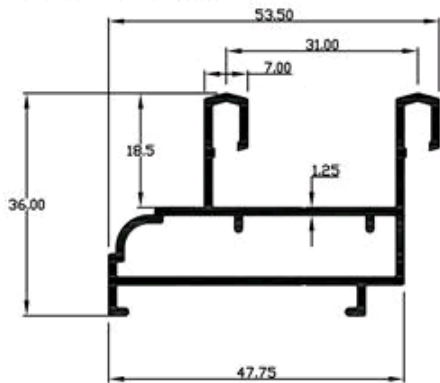

WEIGHT:- 2.400 kg/12'

DUMBHAL (W)

16127

SEC. NO:-16127

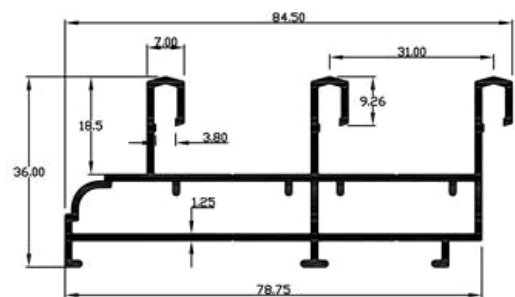

WEIGHT:- 3.860 kg/12'

DUMBHAL (W)

NATIONAL INDUSTRIES

16128

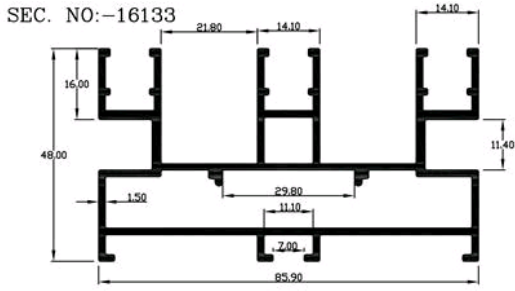

WEIGHT:- 6.466 kg/12'

DUMBHAL (W)

16133

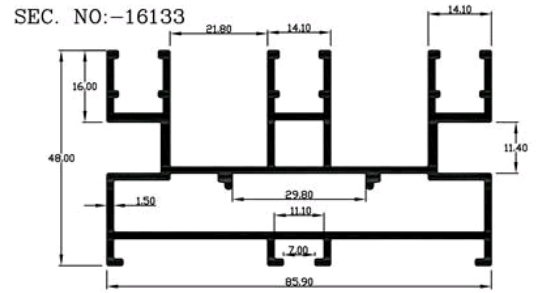

WEIGHT:- 6.466 kg/12'

DUMBHAL (W)

16134

SEC. NO:-16134

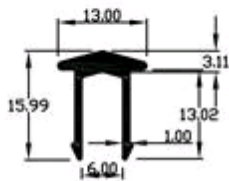

WEIGHT:- 0.552 kg/12'

DUMBHAL (W)

16135

SEC. NO:-16135

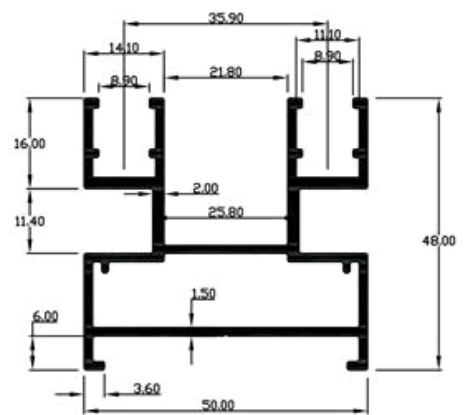

WEIGHT:- 4.065 kg/12'

DUMBHAL (W)

NATIONAL INDUSTRIES

16136

SEC. NO:-16136

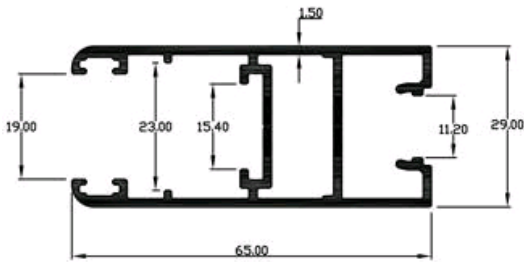

WEIGHT:- 3.553 kg/12'

DUMBHAL (W)

16137

SEC. NO:-16137

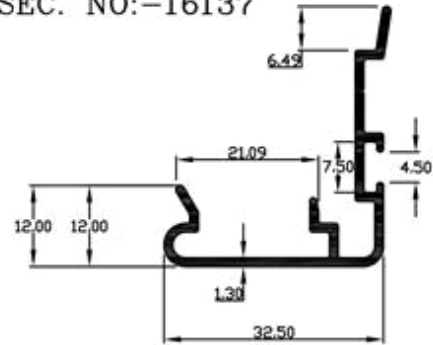

WEIGHT:- 1.333 kg/12'

DUMBHAL (W)

16138

SEC. NO:-16138

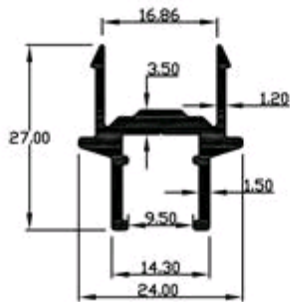

WEIGHT:- 1.434 kg/12'

DUMBHAL (W)

16197

SEC. NO:-16197

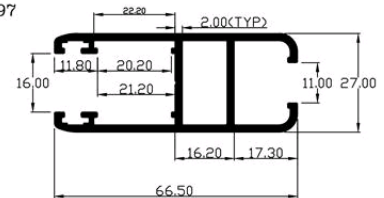

WEIGHT:- 4.057 kg/12'

DUMBHAL (W)

NATIONAL INDUSTRIES

16198

SEC. NO:-16198

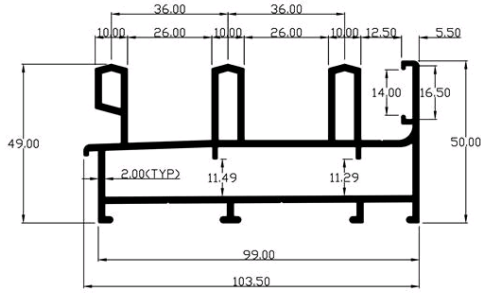

WEIGHT:- 9.029 kg/12'

DUMBHAL (W)

16277

SEC. NO:-16277

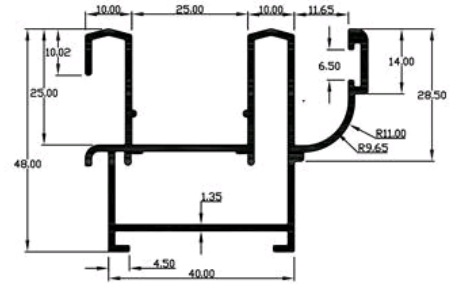

WEIGHT:- 3.745 kg/12'

DUMBHAL (W)

16278

SEC. NO:-16278

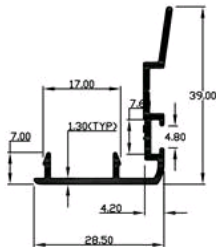

WEIGHT:- 1.117 kg/12'

DUMBHAL (W)

16293

SEC. NO:-16293

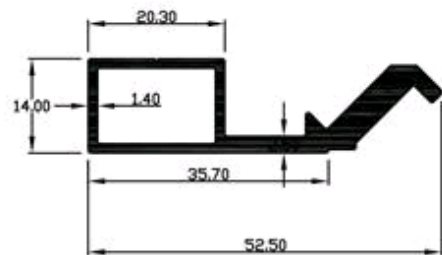

WEIGHT:- 2.143 kg/12'

DUMBHAL (W)

NATIONAL INDUSTRIES

16303

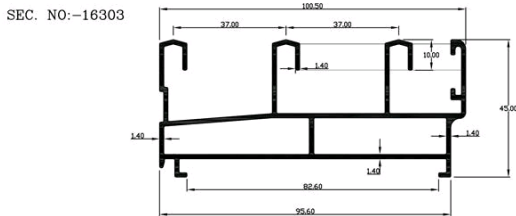

WEIGHT:- 5.665 kg/12'

DUMBHAL (W)

16304

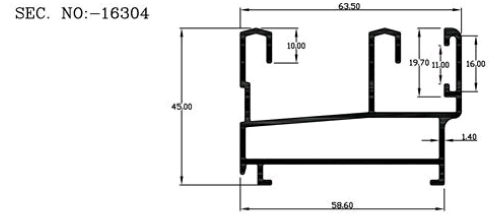

WEIGHT:- 3.925 kg/12'

DUMBHAL (W)

16324

SEC. NO:-16324

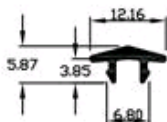

WEIGHT:- 0.250 kg/12'

DUMBHAL (W)

16374

SEC. NO:-16374

N-399

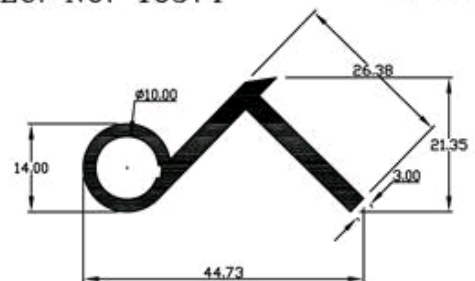

WEIGHT:- 2.046 kg/12'

DUMBHAL (W)

NATIONAL INDUSTRIES

16375

SEC. NO:-16375

N-400

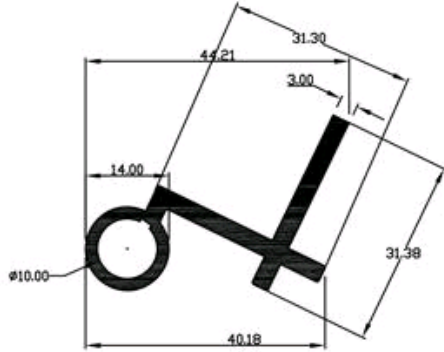

WEIGHT:- 2.563 kg/12'

DUMBHAL (W)

16471

SEC. NO:-16471

N-441

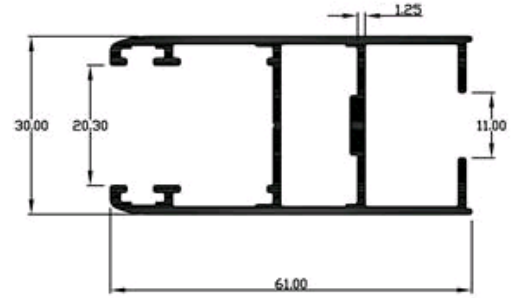

WEIGHT:- 2.888 kg/12'

DUMBHAL (W)

16472

SEC. NO:-16472

N-442

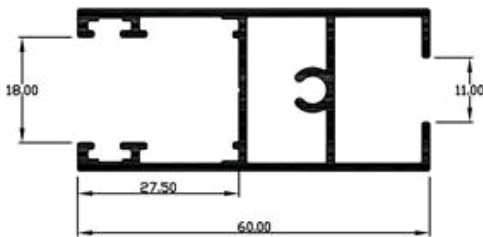

WEIGHT:- 2.895 kg/12'

DUMBHAL (W)

16473

SEC. NO:-16473

N-443

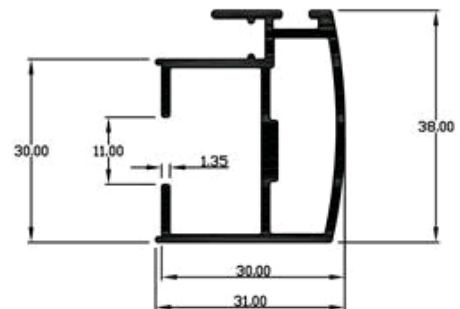

WEIGHT:- 2.243 kg/12'

DUMBHAL (W)

NATIONAL INDUSTRIES

16475

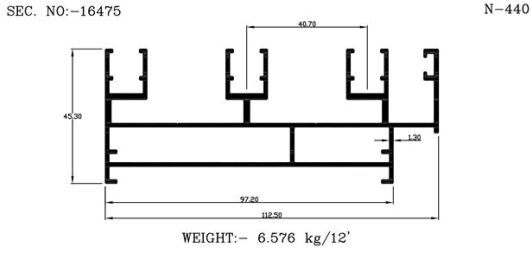

DUMBHAL (W)

16480

SEC. NO:-16480

IND-85

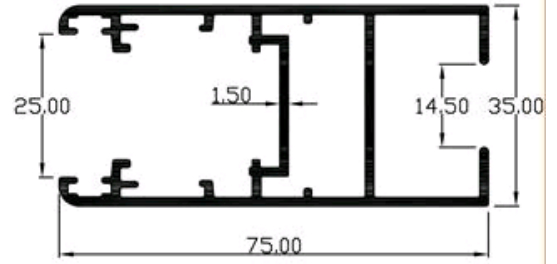

WEIGHT:- 4.222 kg/12'

DUMBHAL (W)

16481

SEC. NO:-16481

IND-86

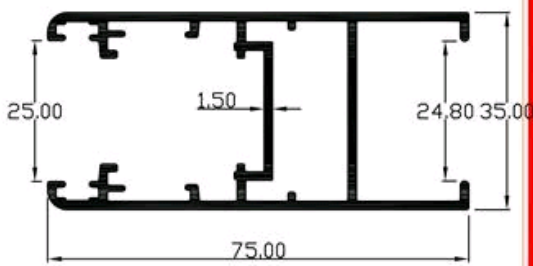

WEIGHT:- 4.070 kg/12'

DUMBHAL (W)

16482

SEC. NO:-16482

IND-87

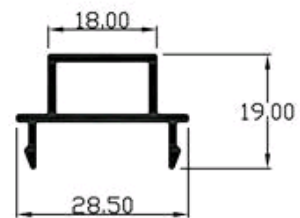

WEIGHT:- 0.946 kg/12'

DUMBHAL (W)

NATIONAL INDUSTRIES

16483

SEC. NO:-16483

IND-88

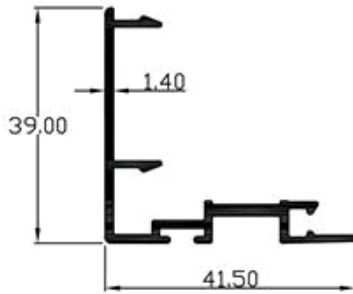

WEIGHT:- 1.567 kg/12'

DUMBHAL (W)

16484

SEC. NO:-16484

IND-84

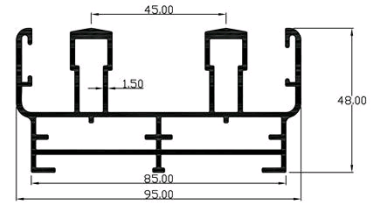

WEIGHT:- 7.580 kg/12'

DUMBHAL (W)

16485

SEC. NO:-16485

IND-83

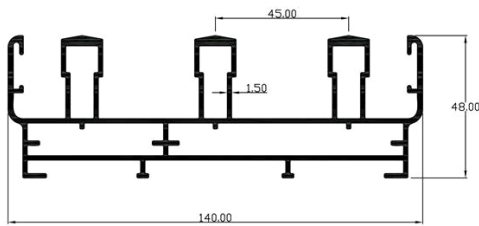

WEIGHT:- 10.241 kg/12'

DUMBHAL (W)

16486

SEC. NO:-16486

N-437

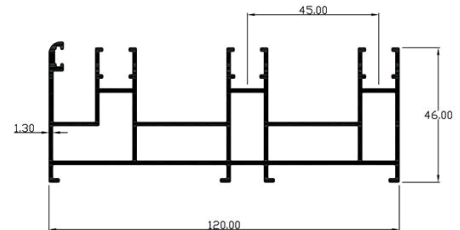

WEIGHT:- 7.061 kg/12'

DUMBHAL (W)

NATIONAL INDUSTRIES

16490

SEC. NO:-16490

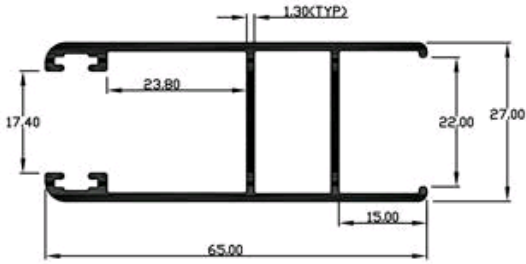

WEIGHT:- 2.688 kg/12'

DUMBHAL (W)

16501

SEC. NO:-16501

IND-91

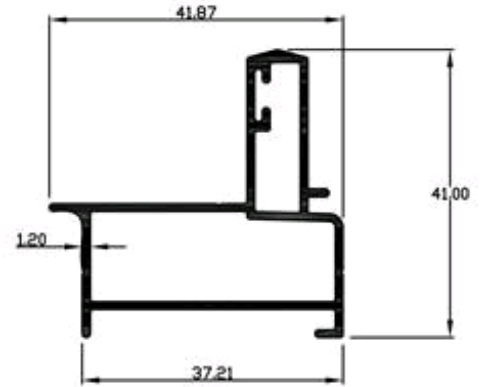

WEIGHT:- 1.966 kg/12'

DUMBHAL (W)

16502

SEC. NO:-16502

IND-92

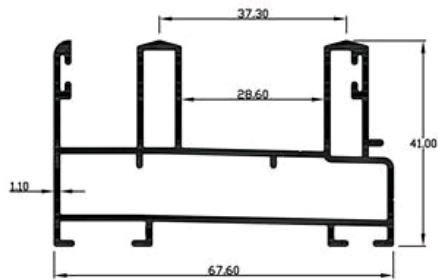

WEIGHT:- 3.700 kg/12'

DUMBHAL (W)

16503

SEC. NO:-16503

IND-93

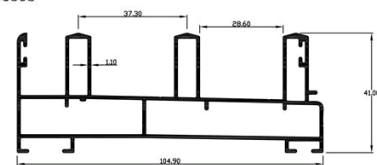

WEIGHT:- 5.280 kg/12'

DUMBHAL (W)

NATIONAL INDUSTRIES

16504

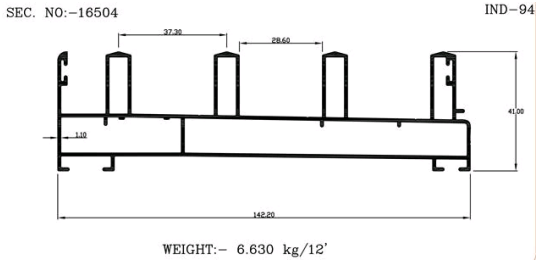

DUMBHAL (W)

16505

SEC. NO:-16505

IND-95

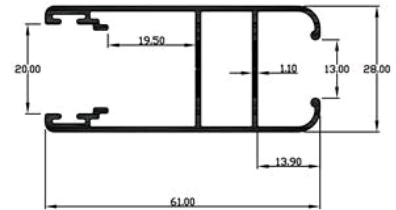

DUMBHAL (W)

16506

SEC. NO:-16506

IND-96

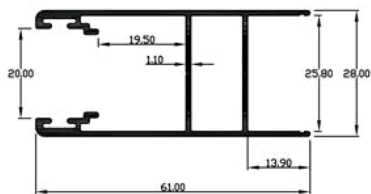

DUMBHAL (W)

16507

SEC. NO:-16507

IND-97

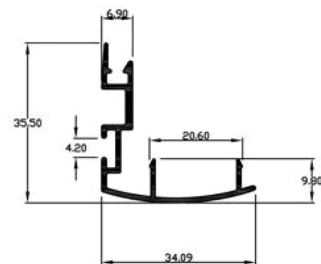

DUMBHAL (W)

NATIONAL INDUSTRIES

16520

SEC. NO:-16520

IND-101

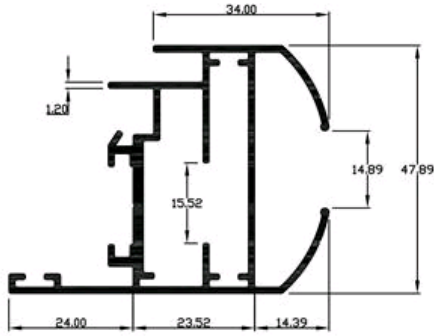

WEIGHT:- 3.755 kg/12'

DUMBHAL (W)

16547

SEC. NO:-16547

N-473

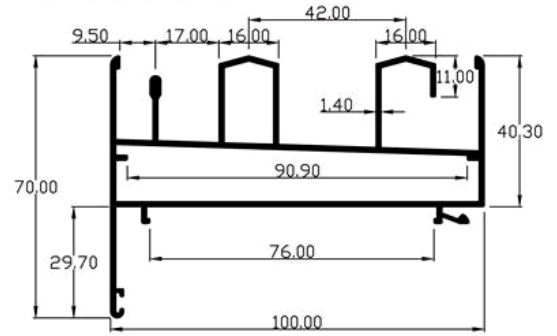

WEIGHT:- 6.379 kg/12'

DUMBHAL (W)

16548

SEC. NO:-16548

N-478

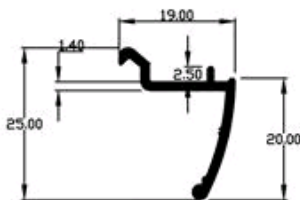

WEIGHT:- 0.640 kg/12'

DUMBHAL (W)

16549

SEC. NO:-16549

N-474

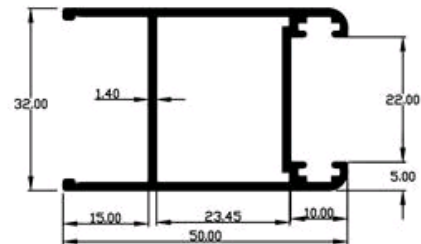

WEIGHT:- 2.415 kg/12'

DUMBHAL (W)

NATIONAL INDUSTRIES

16550

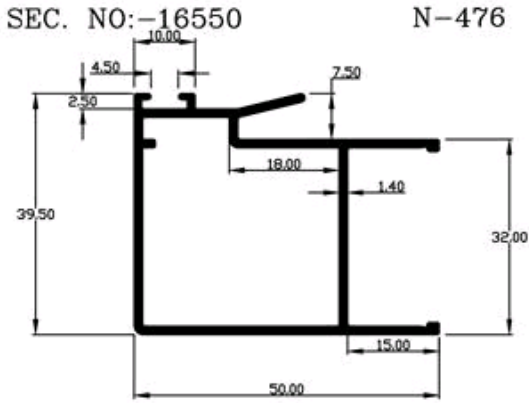

WEIGHT:- 2.614 kg/12'

DUMBHAL (W)

16551

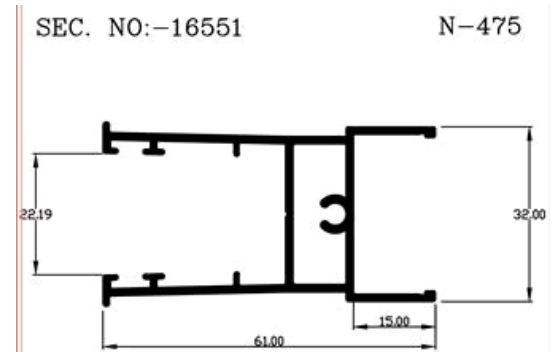

WEIGHT:- 2.915 kg/12'

DUMBHAL (W)

16552

SEC. NO:-16552 N-477

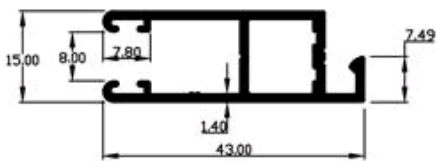

WEIGHT:- 1.700 kg/12'

DUMBHAL (W)

16566

SEC. NO:-16566 N-523

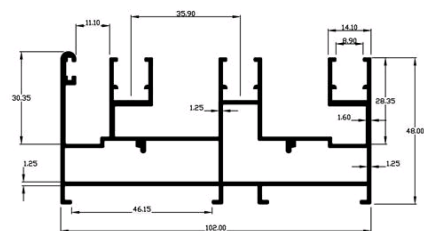

WEIGHT:- 6.543 kg/12'

DUMBHAL (W)

NATIONAL INDUSTRIES

16567

SEC. NO:-16567

N-528

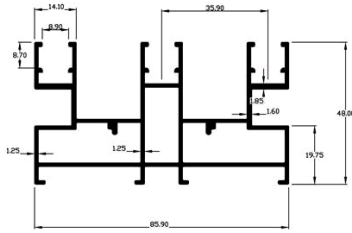

WEIGHT:- 5.768 kg/12'

DUMBHAL (W)

16581

SEC. NO:-16581

N-546

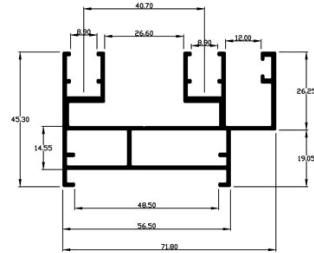

WEIGHT:- 4.634 kg/12'

DUMBHAL (W)

16582

SEC. NO:-16582

IND-113

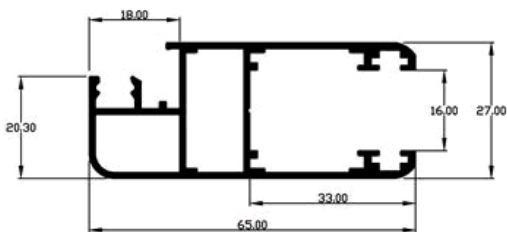

WEIGHT:- 3.043 kg/12'

DUMBHAL (W)

16583

SEC. NO:-16583

IND-114

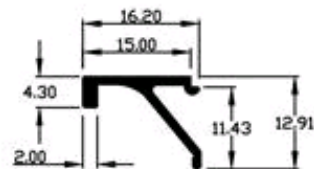

WEIGHT:- 0.418 kg/12'

DUMBHAL (W)

NATIONAL INDUSTRIES

16586

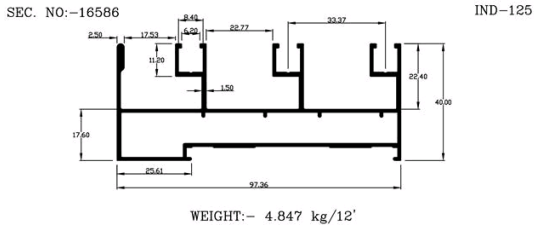

DUMBHAL (W)

16587

SEC. NO:-16587 IND-124

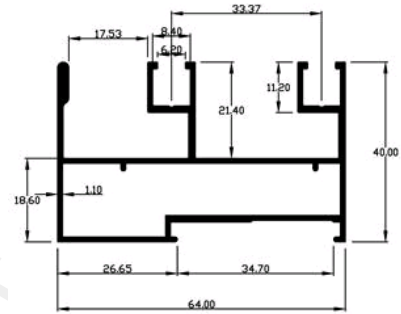

DUMBHAL (W)

16588

SEC. NO:-16588 IND-126

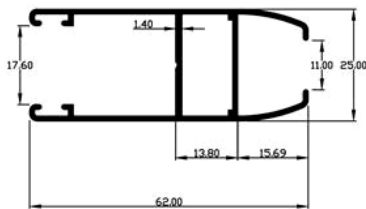

DUMBHAL (W)

16589

SEC. NO:-16589 IND-127

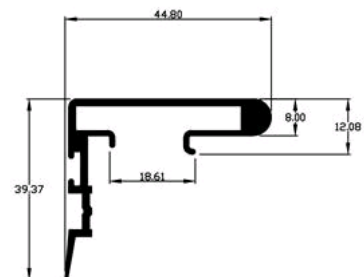

DUMBHAL (W)

NATIONAL INDUSTRIES

16590

SEC. NO:-16590

IND-128

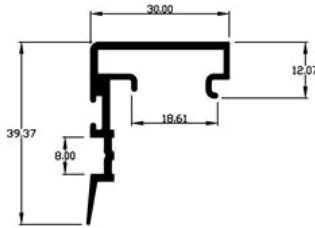

WEIGHT:- 1.457 kg/12'

DUMBHAL (W)

16611

SEC. NO:-16611

IND-131

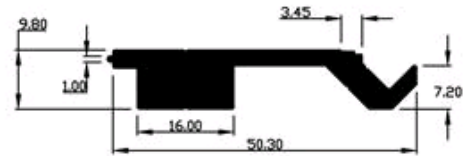

WEIGHT:- 2.782 kg/12'

DUMBHAL (W)

16612

SEC. NO:-16612

IND-132

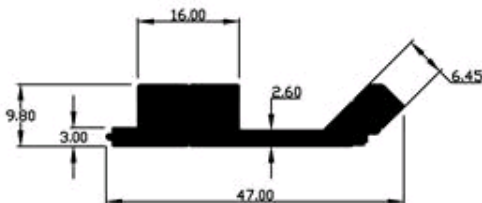

WEIGHT:- 2.727 kg/12'

DUMBHAL (W)

16614

SEC. NO:-16614

N-551

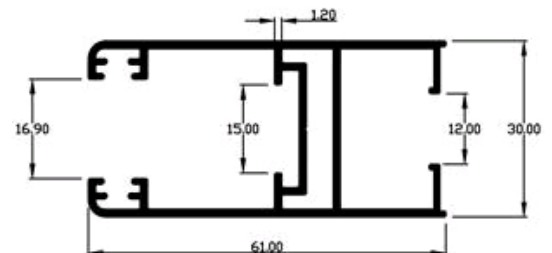

WEIGHT:- 2.938 kg/12'

DUMBHAL (W)

NATIONAL INDUSTRIES

16615

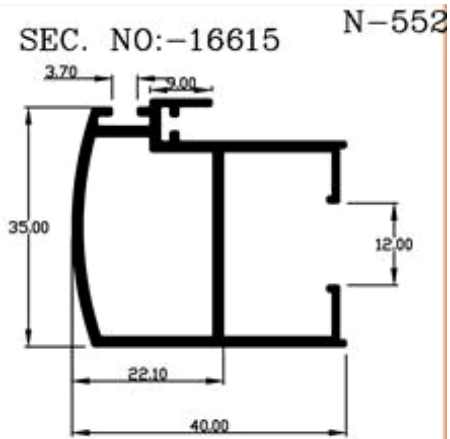

WEIGHT:- 2.400 kg/12'

DUMBHAL (W)

16616

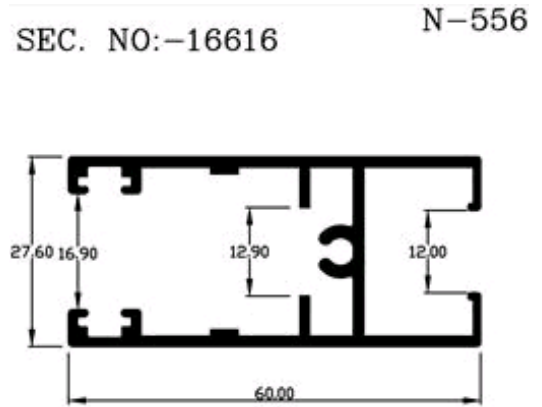

WEIGHT:- 3.009 kg/12'

DUMBHAL (W)

16617

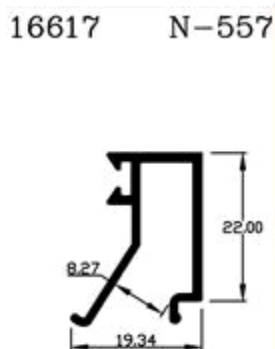

WEIGHT
0.880 kg/12'

DUMBHAL (W)

16618

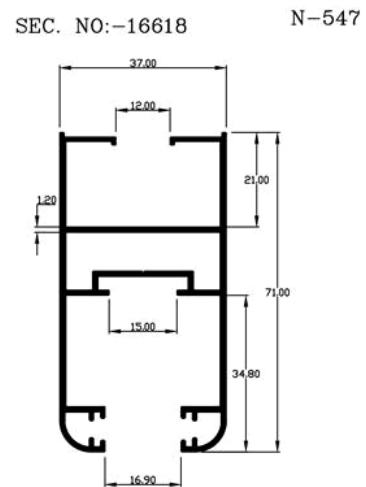

WEIGHT:- 3.597 kg/12'

DUMBHAL (W)

NATIONAL INDUSTRIES

16619

SEC. NO:-16619

N-548

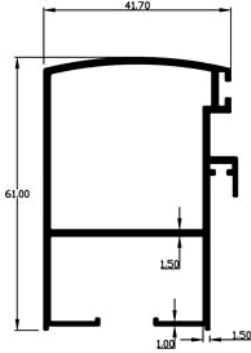

WEIGHT:- 3.355 kg/12'

DUMBHAL (W)

16620

SEC. NO:-16620

N-549

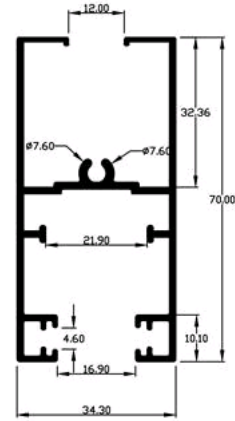

WEIGHT:- 3.491 kg/12'

DUMBHAL (W)

16623

SEC. NO:-16623

IND-125

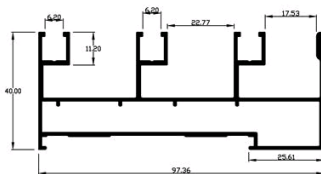

WEIGHT:- 4.857 kg/12'

DUMBHAL (W)

16637

SEC. NO:-16637

N-576

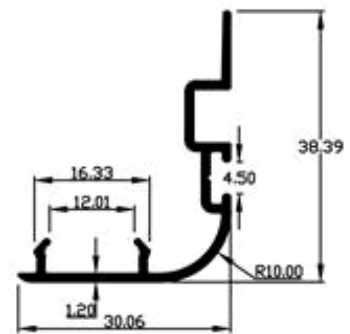

WEIGHT:- 1.012 kg/12'

DUMBHAL (W)

NATIONAL INDUSTRIES

16638

SEC. NO:-16638

N-575

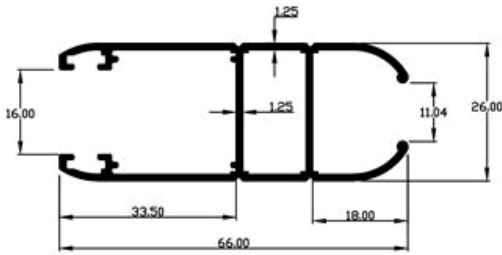

WEIGHT:- 2.530 kg/12'

DUMBHAL (W)

16639

SEC. NO:-166639

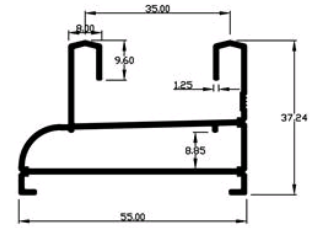

WEIGHT:- 2.608 kg/12'

DUMBHAL (W)

16640

SEC. NO:-16640

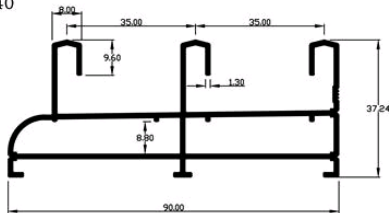

WEIGHT:- 4.319 kg/12'

DUMBHAL (W)

16641

SEC. NO:-16641

N-550

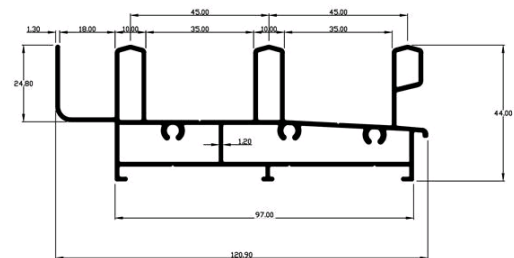

WEIGHT:- 6.462 kg/12'

DUMBHAL (W)

NATIONAL INDUSTRIES

16642

SEC. NO:-16642

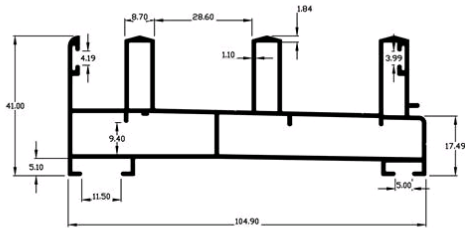

WEIGHT:- 5.280 kg/12'

DUMBHAL (W)

16709

SEC. NO:-16709

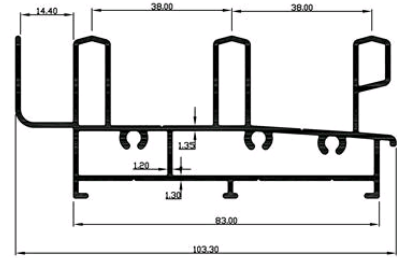

WEIGHT:- 6.052 kg/12'

DUMBHAL (W)

16715

SEC. NO:-16715

N-558

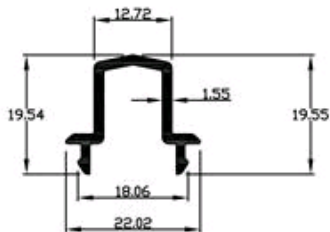

WEIGHT:- 0.817 kg/12'

DUMBHAL (W)

16730

SEC. NO:-16730

N-5

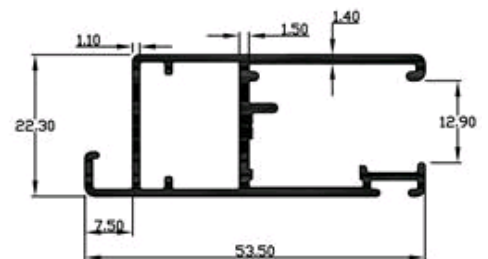

WEIGHT:- 2.120 kg/12'

DUMBHAL (W)

NATIONAL INDUSTRIES

16731

SEC. NO:-16731

N

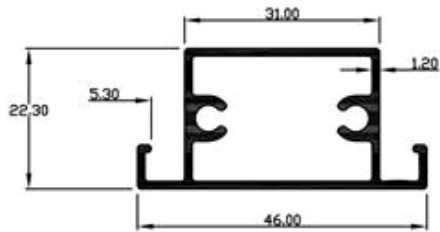

WEIGHT:- 1.951 kg/12'

DUMBHAL (W)

16732

SEC. NO:-16732

N

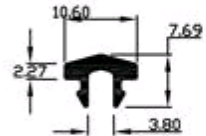

WEIGHT:- 0.350 kg/12'

DUMBHAL (W)

16733

SEC. NO:-16733

N-599

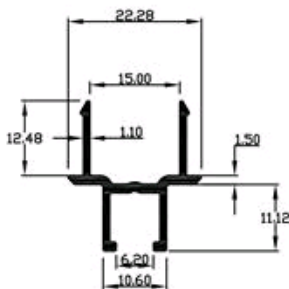

WEIGHT:- 0.862 kg/12'

DUMBHAL (W)

16734

SEC. NO:-16734

N-616

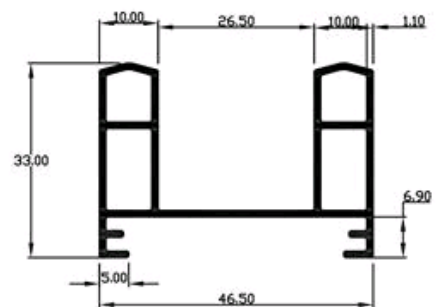

WEIGHT:- 2.196 kg/12'

DUMBHAL (W)

NATIONAL INDUSTRIES

16735

SEC. NO:-16735

N-617

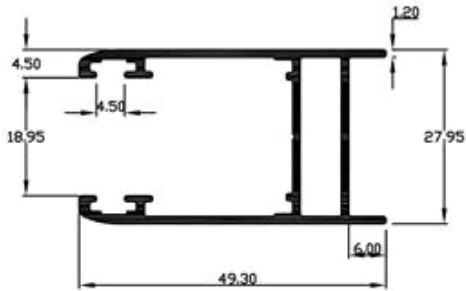

WEIGHT:- 2.106 kg/12'

DUMBHAL (W)

16736

SEC. NO:-16736

N-618

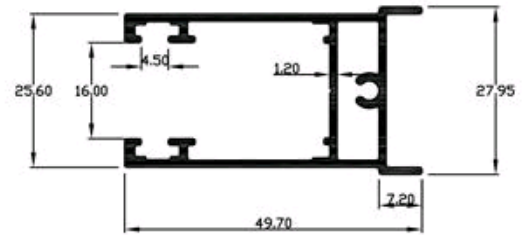

WEIGHT:- 2.263 kg/12'

DUMBHAL (W)

16737

SEC. NO:-16737

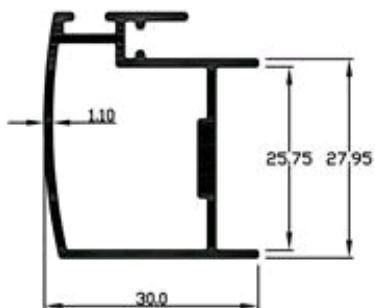

WEIGHT:- 1.634 kg/12'

DUMBHAL (W)

16765

SEC. NO:-16765

N-600

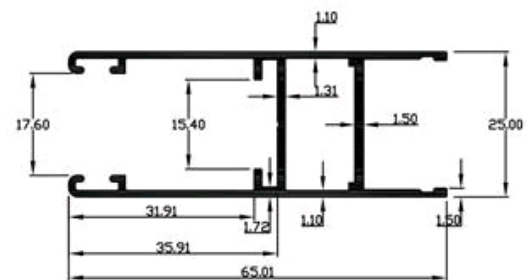

WEIGHT:- 2.379 kg/12'

DUMBHAL (W)

NATIONAL INDUSTRIES

16773

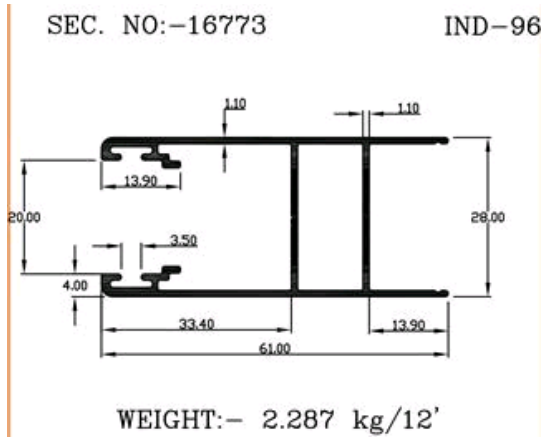

DUMBHAL (W)

16774

SEC. NO:-16774

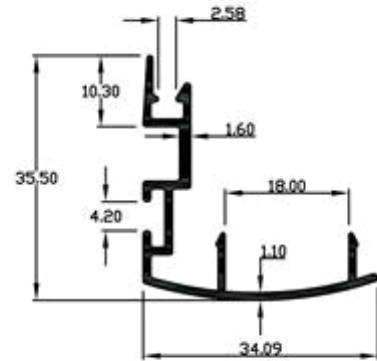

DUMBHAL (W)

16793

SEC. NO:-16793 N-675

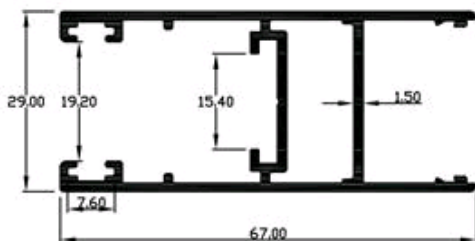

DUMBHAL (W)

16794

SEC. NO:-16794 N-678

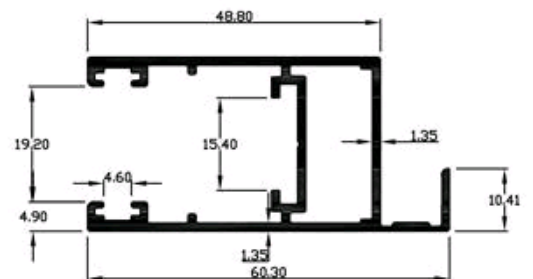

DUMBHAL (W)

NATIONAL INDUSTRIES

16795

SEC. NO:-16795

N-679

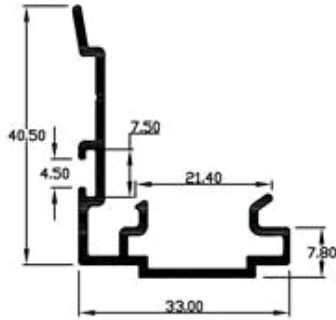

WEIGHT:- 1.413 kg/12'

DUMBHAL (W)

16830

SEC. NO:-16830

N-693

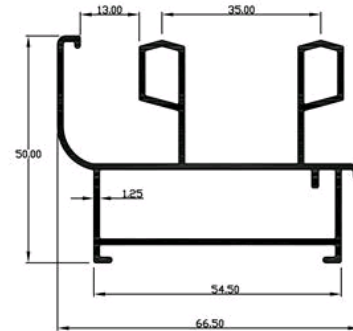

WEIGHT:- 3.801 kg/12'

DUMBHAL (W)

16831

SEC. NO:-16831

IND-205

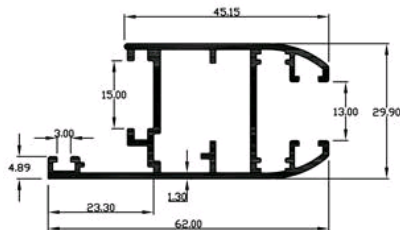

WEIGHT:- 2.912 kg/12'

DUMBHAL (W)

16832

SEC. NO:-16832

IND-206



WEIGHT:- 0.547 kg/12'

DUMBHAL (W)

NATIONAL INDUSTRIES

16853

SEC. NO:-16853

N-710

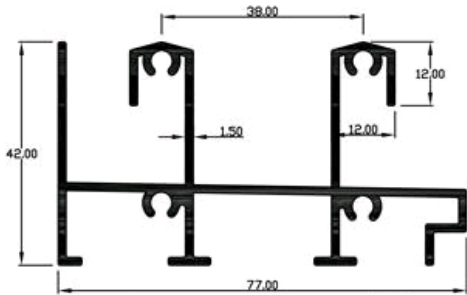

WEIGHT:- 4.614 kg/12'

DUMBHAL (W)

16854

SEC. NO:-16854

N-712

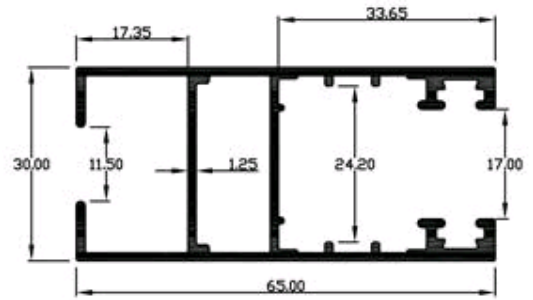

WEIGHT:- 3.296 kg/12'

DUMBHAL (W)

16855

SEC. NO:-16855

N-713

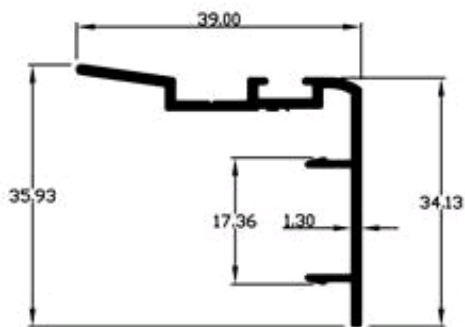

WEIGHT:- 1.167 kg/12'

DUMBHAL (W)

16856

SEC. NO:-16856

N-711

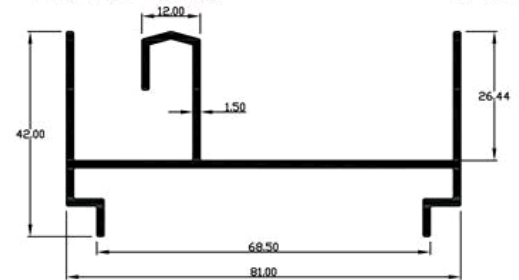

WEIGHT:- 3.251 kg/12'

DUMBHAL (W)