

NATIONAL INDUSTRIES

12557

SEC. NO:-12557

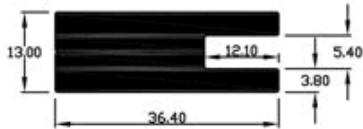

WEIGHT:-4.033-4.300 kg/12'

HARDWARE GROUP

12558

SEC. NO:-12558

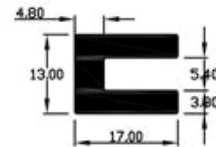

WEIGHT:-1.530-1.800 kg/12'

HARDWARE GROUP

13111

SEC. NO:-13111

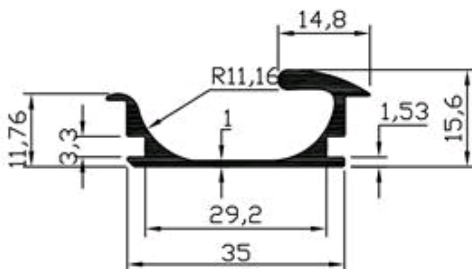

WEIGHT:- 1.300-1.400 kg/12'

HARDWARE GROUP

13116

SEC. NO:-13116

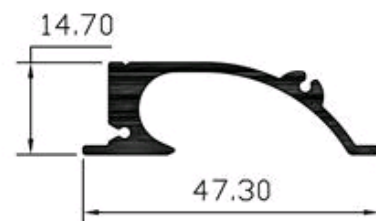

WEIGHT:- 0.850-1.000 kg/12'

HARDWARE GROUP

NATIONAL INDUSTRIES

14816

SEC. NO:-14816

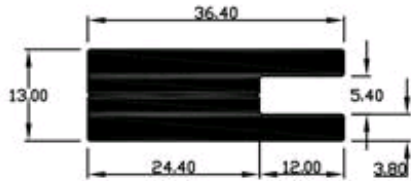

WEIGHT:- 4.032 kg/12'

HARDWARE GROUP

14821

SEC. NO:-14821

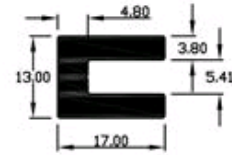

WEIGHT:- 1.530 kg/12'

HARDWARE GROUP

14886

SEC. NO:-14886

BH

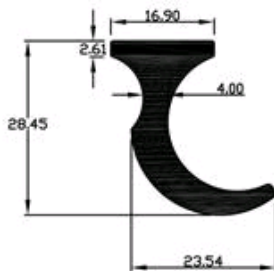

WEIGHT:- 2.500 kg/12'

HARDWARE GROUP

14951

SEC. NO:-14951

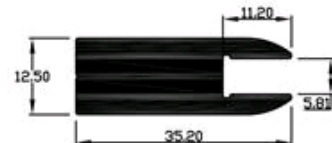

WEIGHT:- 3.570 kg/12'

HARDWARE GROUP

NATIONAL INDUSTRIES

14956

SEC. NO:-14956

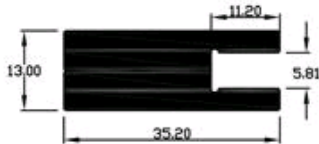

WEIGHT:- 3.860 kg/12'

HARDWARE GROUP

14966

SEC. NO:-14966

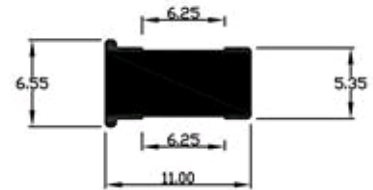

WEIGHT:- 0.565 kg/12'

HARDWARE GROUP

14971

SEC. NO:-14971

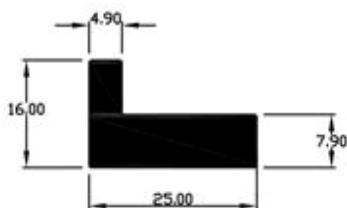

WEIGHT:- 2.342 kg/12'

HARDWARE GROUP

14981

SEC. NO:-14981

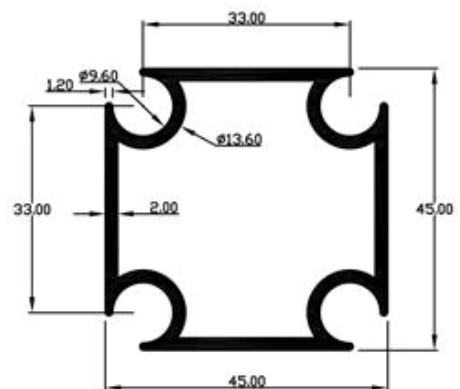

WEIGHT:- 3.952 kg/12'

HARDWARE GROUP

NATIONAL INDUSTRIES

14996

SEC. NO:-14996

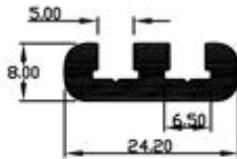

WEIGHT:- 1.300 kg/12'

HARDWARE GROUP

15001

SEC. NO:-15001

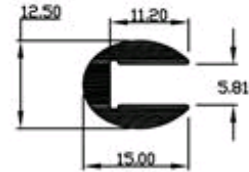

WEIGHT:- 0.867 kg/12'

HARDWARE GROUP

15056

SEC. NO:-15056

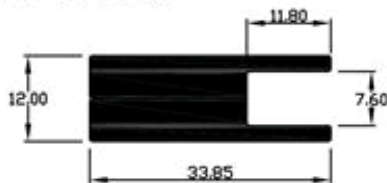

WEIGHT:- 3.125 kg/12'

HARDWARE GROUP

15061

SEC. NO:-15061

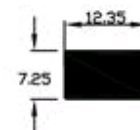

WEIGHT:- 0.883 kg/12'

HARDWARE GROUP

NATIONAL INDUSTRIES

15146

SEC. NO:-15146

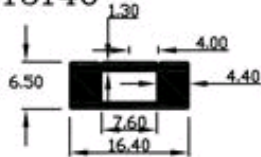

WEIGHT:- 0.734 kg/12'

HARDWARE GROUP

15181

SEC. NO:-15181

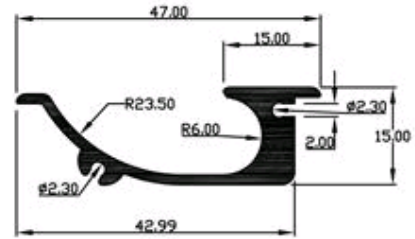

WEIGHT:- 1.713 kg/12'

HARDWARE GROUP

15186

SEC. NO:-15186

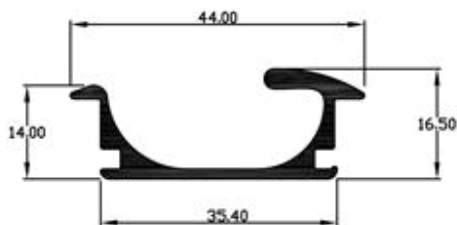

WEIGHT:- 1.567 kg/12'

HARDWARE GROUP

15291

SEC. NO:-15291

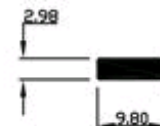

WEIGHT:- 0.287 kg/12'

HARDWARE GROUP

NATIONAL INDUSTRIES

15296

SEC. NO:-15296

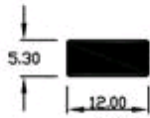

WEIGHT:- 0.627 kg/12'

HARDWARE GROUP

15376

SEC. NO:-15376

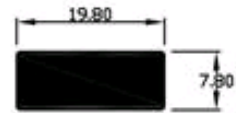

WEIGHT:- 1.500 kg/12'

HARDWARE GROUP

15381

SEC. NO:-15381

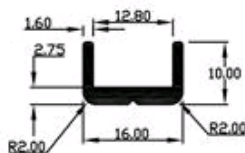

WEIGHT:- 0.640 kg/12'

HARDWARE GROUP

15451

SEC. NO:-15451

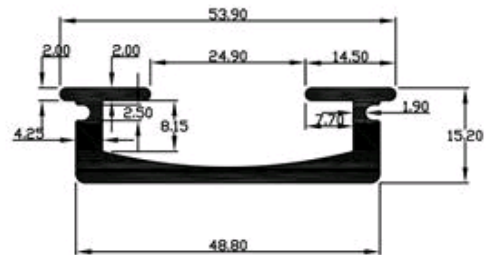

WEIGHT:- 2.882 kg/12'

HARDWARE GROUP

NATIONAL INDUSTRIES

15456

SEC. NO:-15456

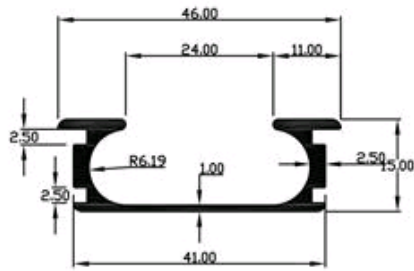

WEIGHT:- 1.453 kg/12'

HARDWARE GROUP

15461

SEC. NO:-15461

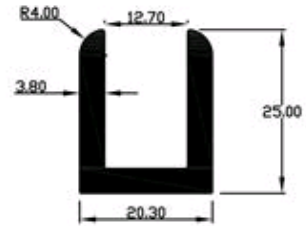

WEIGHT:- 2.289 kg/12'

HARDWARE GROUP

15466

SEC. NO:-15466



WEIGHT:- 2.041 kg/12'

HARDWARE GROUP

15526

SEC. NO:-15526

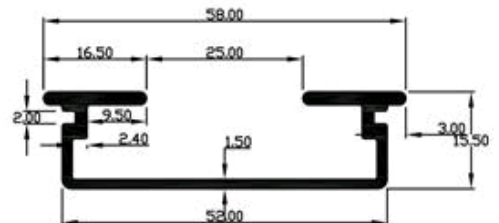

WEIGHT:- 2.074 kg/12'

HARDWARE GROUP

NATIONAL INDUSTRIES

15536

SEC. NO:-15536



WEIGHT:- 0.710 kg/12'

HARDWARE GROUP

15566

SEC. NO:-15566



WEIGHT:- 2.357 kg/12'

HARDWARE GROUP

15571

SEC. NO:-15571

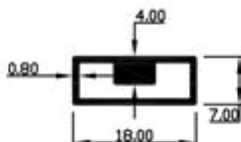

WEIGHT:- 0.560 kg/12'

HARDWARE GROUP

15576

SEC. NO:-15576

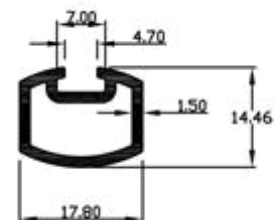

WEIGHT:- 0.888 kg/12'

HARDWARE GROUP

NATIONAL INDUSTRIES

15581

SEC. NO:-15581

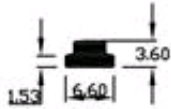

WEIGHT:- 0.188 kg/12'

HARDWARE GROUP

15586

SEC. NO:-15586



WEIGHT:- 0.296 kg/12'

HARDWARE GROUP

15591

SEC. NO:-15591

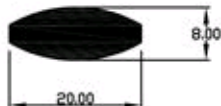

WEIGHT:- 1.237 kg/12'

HARDWARE GROUP

15596

SEC. NO:-15596

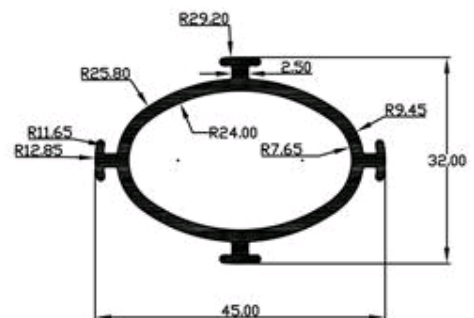

WEIGHT:- 2.178 kg/12'

HARDWARE GROUP

NATIONAL INDUSTRIES

15598

SEC. NO:-15598



WEIGHT:- 0.637 kg/12'

HARDWARE GROUP

15601

SEC. NO:-15601

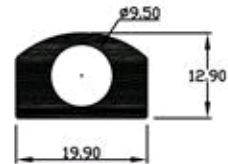

WEIGHT:- 1.600 kg/12'

HARDWARE GROUP

15606

SEC. NO:-15606

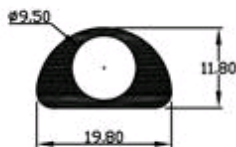

WEIGHT:- 1.170 kg/12'

HARDWARE GROUP

15621

SEC. NO:-15621

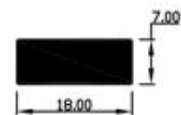

WEIGHT:- 1.244 kg/12'

HARDWARE GROUP

NATIONAL INDUSTRIES

15666

SEC. NO:-15666

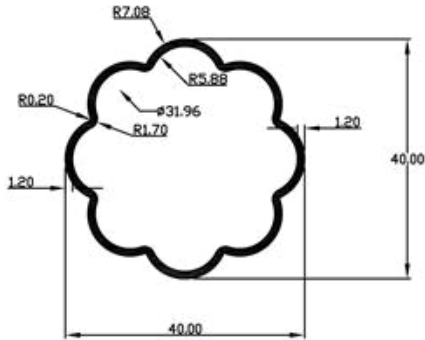

WEIGHT:- 1.500 kg/12'

HARDWARE GROUP

15671

SEC. NO:-15671

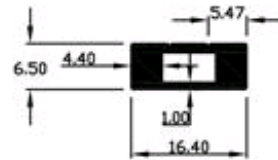

WEIGHT:- 0.735 kg/12'

HARDWARE GROUP

15831

SEC. NO:-15831



WEIGHT:- 2.365 kg/12'

HARDWARE GROUP

15961

SEC. NO:-15961

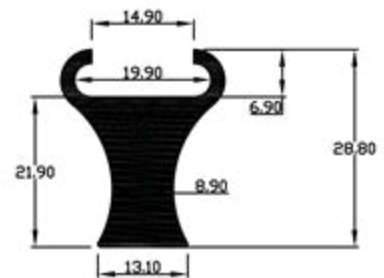

WEIGHT:- 2.950 kg/12'

HARDWARE GROUP

NATIONAL INDUSTRIES

15962

SEC. NO:-15962



WEIGHT:- 1.133 kg/12'

HARDWARE GROUP

15963

SEC. NO:-15963

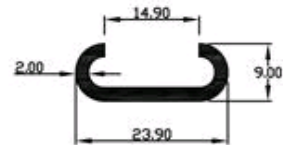

WEIGHT:- 0.746 kg/12'

HARDWARE GROUP

16007

SEC. NO:-16007

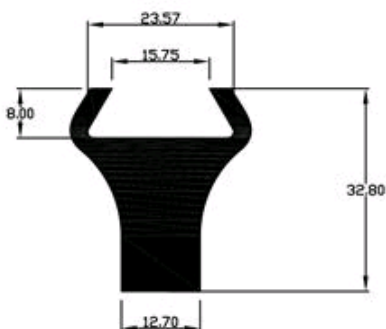

WEIGHT:- 4.467 kg/12'

HARDWARE GROUP

16008

SEC. NO:-16008

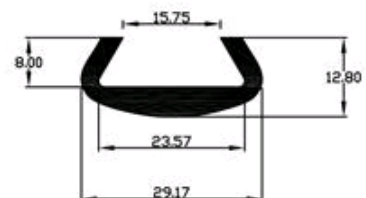

WEIGHT:- 1.548 kg/12'

HARDWARE GROUP

NATIONAL INDUSTRIES

16009

SEC. NO:-16009



WEIGHT:- 1.500 kg/12'

HARDWARE GROUP

16010

SEC. NO:-16010

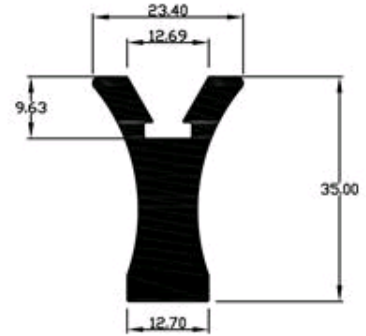

WEIGHT:- 3.684 kg/12'

HARDWARE GROUP

16011

SEC. NO:-16011

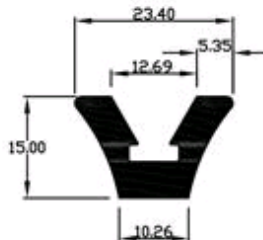

WEIGHT:- 1.600 kg/12'

HARDWARE GROUP

16012

SEC. NO:-16012

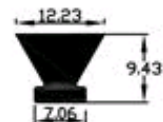

WEIGHT:- 0.727 kg/12'

HARDWARE GROUP

NATIONAL INDUSTRIES

16038

SEC. NO:-16038

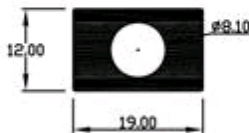

WEIGHT:- 1.743 kg/12'

HARDWARE GROUP

16039

SEC. NO:-16039

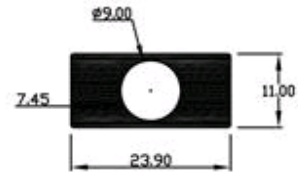

WEIGHT:- 1.968 kg/12'

HARDWARE GROUP

16053

SEC. NO:-16053

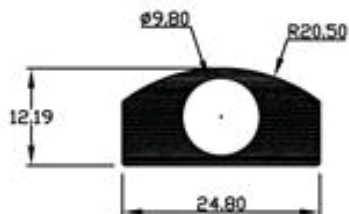

WEIGHT:- 1.915 kg/12'

HARDWARE GROUP

16076

SEC. NO:-16076

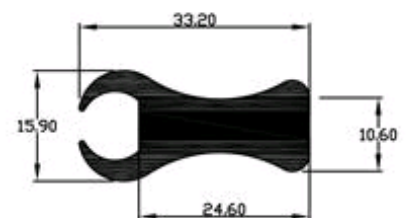

WEIGHT:- 2.933 kg/12'

HARDWARE GROUP

NATIONAL INDUSTRIES

16077

SEC. NO:-16077

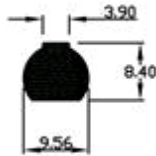

WEIGHT:- 0.656 kg/12'

HARDWARE GROUP

16078

SEC. NO:-16078

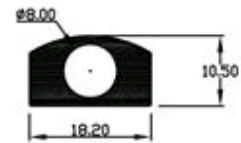

WEIGHT:- 1.243 kg/12'

HARDWARE GROUP

16079

SEC. NO:-16079



WEIGHT:- 0.970 kg/12'

HARDWARE GROUP

16080

SEC. NO:-16080

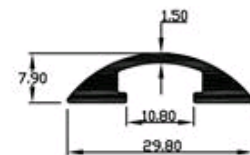

WEIGHT:- 0.913 kg/12'

HARDWARE GROUP

NATIONAL INDUSTRIES

16081

SEC. NO:-16081

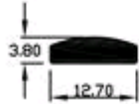

WEIGHT:- 0.424 kg/12'

HARDWARE GROUP

16082

SEC. NO:-16082

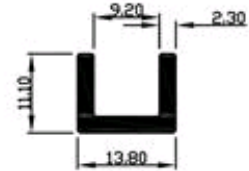

WEIGHT:- 0.712 kg/12'

HARDWARE GROUP

16083

SEC. NO:-16083

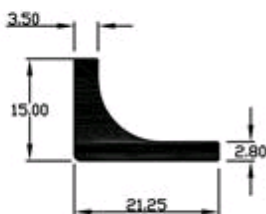

WEIGHT:- 1.188 kg/12'

HARDWARE GROUP

16085

SEC. NO:-16085

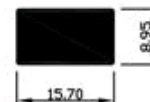

WEIGHT:- 1.387 kg/12'

HARDWARE GROUP

NATIONAL INDUSTRIES

16086

SEC. NO:-16086

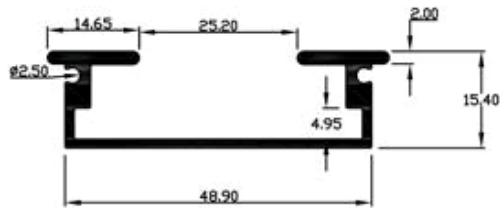

WEIGHT:- 1.862 kg/12'

HARDWARE GROUP

16087

SEC. NO:-16087

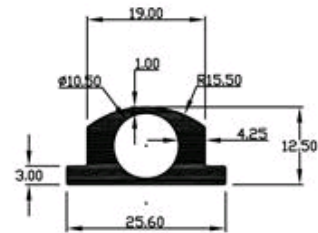

WEIGHT:- 1.500 kg/12'

HARDWARE GROUP

16088

SEC. NO:-16088

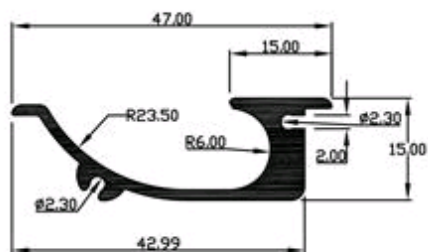

WEIGHT:- 1.713 kg/12'

HARDWARE GROUP

16098

SEC. NO:-16098

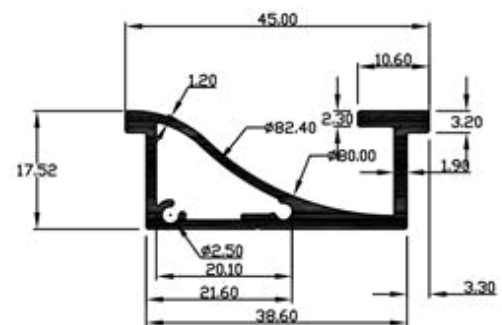

WEIGHT:- 2.000 kg/12'

HARDWARE GROUP

NATIONAL INDUSTRIES

16100

SEC. NO:-16100

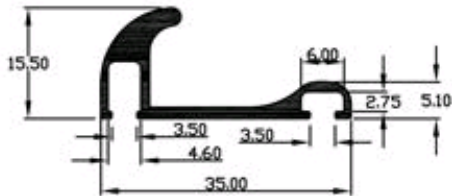

WEIGHT:- 1.122 kg/12'

HARDWARE GROUP

16110

SEC. NO:-16110

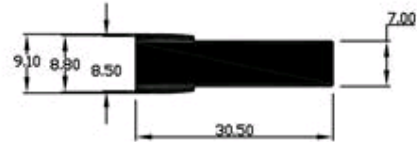

WEIGHT:- 2.280 kg/12'

HARDWARE GROUP

16170

SEC. NO:-16170

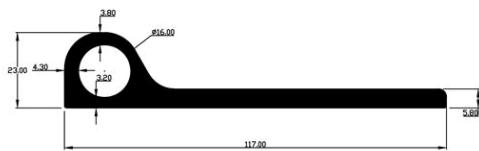

WEIGHT:- 8.421 kg/12'

HARDWARE GROUP

16171

SEC. NO:-16171

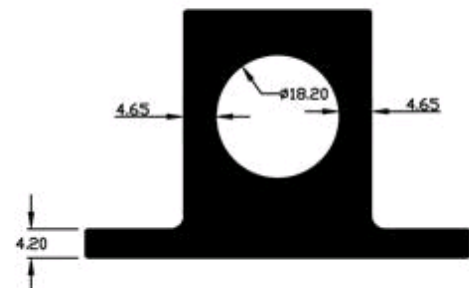

WEIGHT:- 8.512 kg/12'

HARDWARE GROUP

NATIONAL INDUSTRIES

16172

SEC. NO:-16172

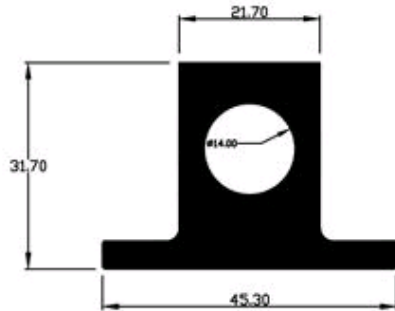

WEIGHT:- 6.295 kg/12'

HARDWARE GROUP

16173

SEC. NO:-16173

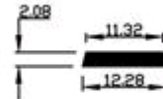

WEIGHT:- 0.242 kg/12'

HARDWARE GROUP

16174

SEC. NO:-16174



WEIGHT:- 0.168 kg/12'

HARDWARE GROUP

16175

SEC. NO:-16175

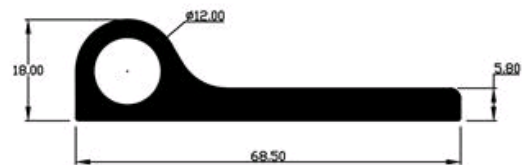

WEIGHT:- 4.792 kg/12'

HARDWARE GROUP

NATIONAL INDUSTRIES

16186

SEC. NO:-16186

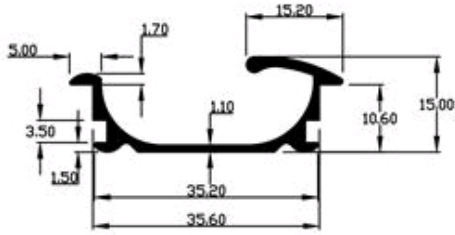

WEIGHT:- 1.106 kg/12'

HARDWARE GROUP

16187

SEC. NO:-16187

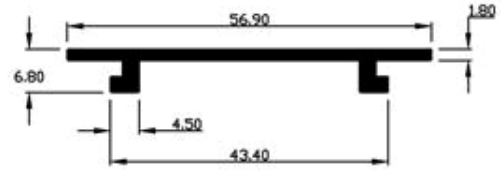

WEIGHT:- 1.361 kg/12'

HARDWARE GROUP

16188

SEC. NO:-16188

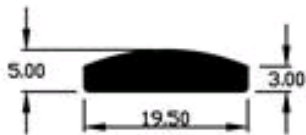

WEIGHT:- 0.836 kg/12'

HARDWARE GROUP

16189

SEC. NO:-16189

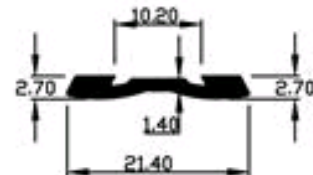

WEIGHT:- 0.415 kg/12'

HARDWARE GROUP

NATIONAL INDUSTRIES

16190

SEC. NO:-16190

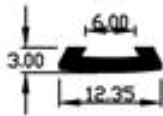

WEIGHT:- 0.248 kg/12'

HARDWARE GROUP

16191

SEC. NO:-16191

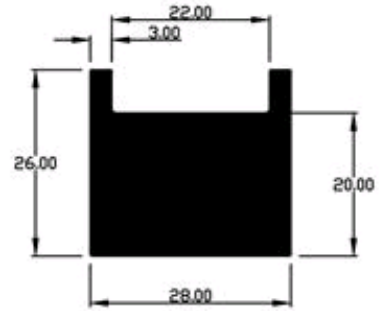

WEIGHT:- 5.889 kg/12'

HARDWARE GROUP

16192

SEC. NO:-16192



WEIGHT:- 1.303 kg/12'

HARDWARE GROUP

16193

SEC. NO:-16193

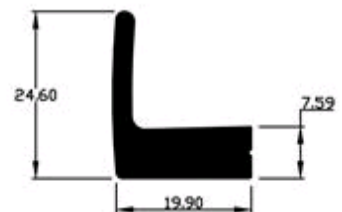

WEIGHT:- 1.930 kg/12'

HARDWARE GROUP

NATIONAL INDUSTRIES

16194

SEC. NO:-16194

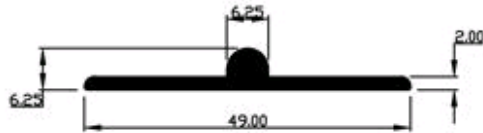

WEIGHT:- 1.179 kg/12'

HARDWARE GROUP

16195

SEC. NO:-16195

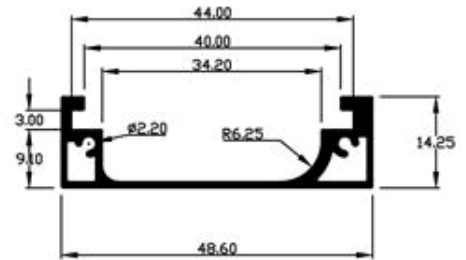

WEIGHT:- 1.406 kg/12'

HARDWARE GROUP

16224

SEC. NO:-16224

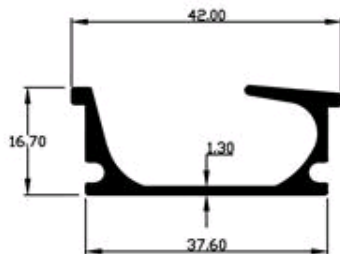

WEIGHT:- 1.541 kg/12'

HARDWARE GROUP

16225

SEC. NO:-16225

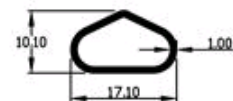

WEIGHT:- 0.404 kg/12'

HARDWARE GROUP

NATIONAL INDUSTRIES

16226

SEC. NO:-16226

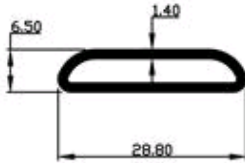

WEIGHT:- 0.827 kg/12'

HARDWARE GROUP

16227

SEC. NO:-16227



WEIGHT:- 1.126 kg/12'

HARDWARE GROUP

16228

SEC. NO:-16228

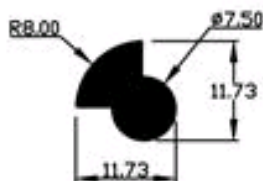

WEIGHT:- 0.807 kg/12'

HARDWARE GROUP

16230

SEC. NO:-16230

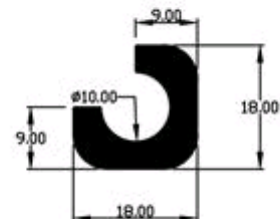

WEIGHT:- 1.660 kg/12'

HARDWARE GROUP

NATIONAL INDUSTRIES

16231

SEC. NO:-16231

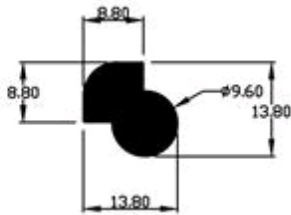

WEIGHT:- 1.267 kg/12'

HARDWARE GROUP

16232

SEC. NO:-16232

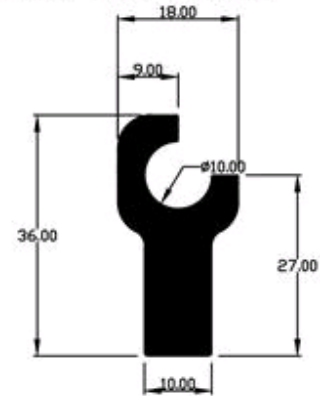

WEIGHT:- 3.447 kg/12'

HARDWARE GROUP

16233

SEC. NO:-16233

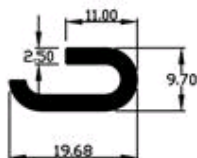

WEIGHT:- 0.814 kg/12'

HARDWARE GROUP

16234

SEC. NO:-16234

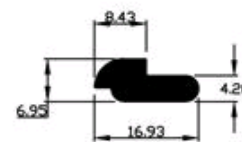

WEIGHT:- 0.794 kg/12'

HARDWARE GROUP

NATIONAL INDUSTRIES

16235

SEC. NO:-16235



WEIGHT:- 0.147 kg/12'

HARDWARE GROUP

16259

SEC. NO:-16259

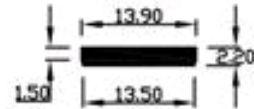

WEIGHT:- 0.300 kg/12'

HARDWARE GROUP

16260

SEC. NO:-16260



WEIGHT:- 2.371 kg/12'

HARDWARE GROUP

16261

SEC. NO:-16261



WEIGHT:- 1.481 kg/12'

HARDWARE GROUP

NATIONAL INDUSTRIES

16262

SEC. NO:-16262

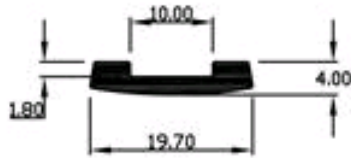

WEIGHT:- 0.531 kg/12'

HARDWARE GROUP

16263

SEC. NO:-16263

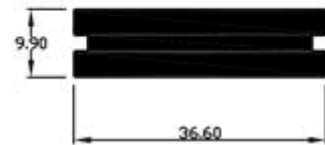

WEIGHT:- 3.492 kg/12'

HARDWARE GROUP

16264

SEC. NO:-16264

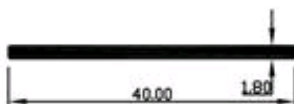

WEIGHT:- 0.711 kg/12'

HARDWARE GROUP

16265

SEC. NO:-16265

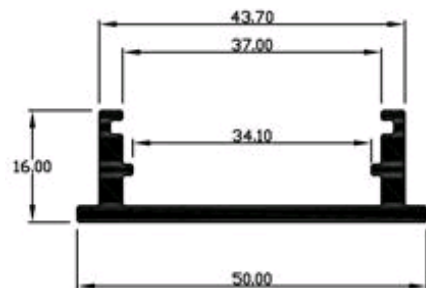

WEIGHT:- 2.040 kg/12'

HARDWARE GROUP

NATIONAL INDUSTRIES

16325

SEC. NO:-16325



WEIGHT:- 1.900 kg/12'

HARDWARE GROUP

16328

SEC. NO:-16328

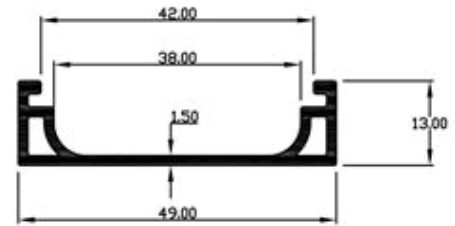

WEIGHT:- 1.450 kg/12'

HARDWARE GROUP

16329

SEC. NO:-16329

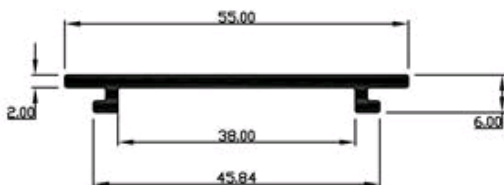

WEIGHT:- 1.300 kg/12'

HARDWARE GROUP

16331

SEC. NO:-16331



WEIGHT:- 3.500 kg/12'

HARDWARE GROUP

NATIONAL INDUSTRIES

16332

SEC. NO:-16332

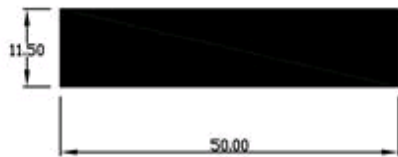

WEIGHT:- 5.682 kg/12'

HARDWARE GROUP

16333

SEC. NO:-16333

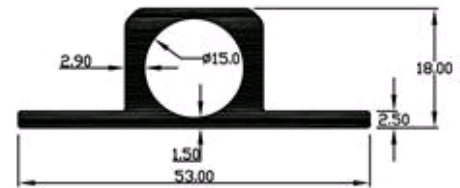

WEIGHT:- 2.700 kg/12'

HARDWARE GROUP

16334

SEC. NO:-16334

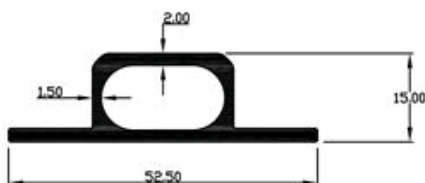

WEIGHT:- 2.135 kg/12'

HARDWARE GROUP

16396

SEC. NO:-16396

N-406

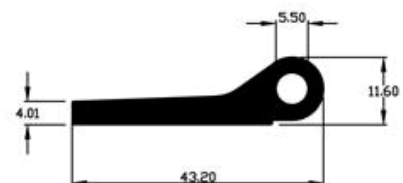

WEIGHT:- 2.348 kg/12'

HARDWARE GROUP

NATIONAL INDUSTRIES

16397

SEC. NO:-16397

N-407

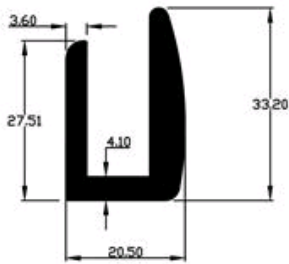

WEIGHT:- 3.102 kg/12'

HARDWARE GROUP

16398

SEC. NO:-16398

N-408

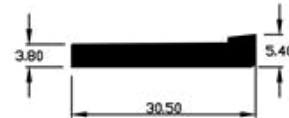

WEIGHT:- 1.228 kg/12'

HARDWARE GROUP

16399

SEC. NO:-16399

N-409

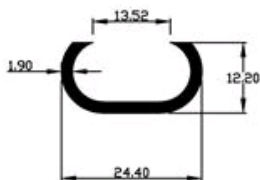

WEIGHT:- 0.776 kg/12'

HARDWARE GROUP

16400

SEC. NO:-16400

N-435



WEIGHT:- 0.650 kg/12'

HARDWARE GROUP

NATIONAL INDUSTRIES

16465

SEC. NO:-16465

N-446

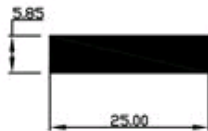

WEIGHT:- 1.445 kg/12'

HARDWARE GROUP

16716

SEC. NO:-16716

N-583

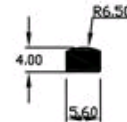

WEIGHT:- 0.210 kg/12'

HARDWARE GROUP

16775

SEC. NO:-16775

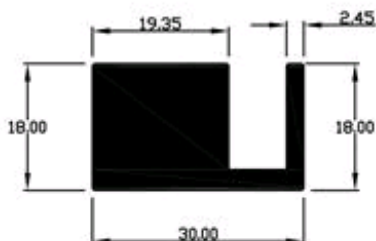

WEIGHT:- 4.114 kg/12'

HARDWARE GROUP

16776

SEC. NO:-16776

N-626



WEIGHT:- 1.335 kg/12'

HARDWARE GROUP

NATIONAL INDUSTRIES

16777

SEC. NO:-16777

N-628

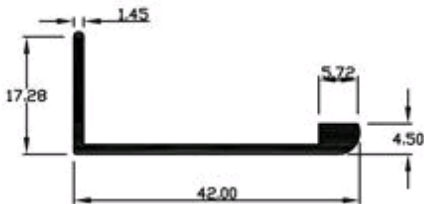

WEIGHT:- 0.994 kg/12'

HARDWARE GROUP

16778

SEC. NO:-16778

N-627

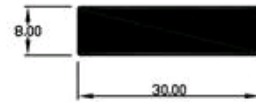

WEIGHT:- 2.370 kg/12'

HARDWARE GROUP

16779

SEC. NO:-16779

N-629

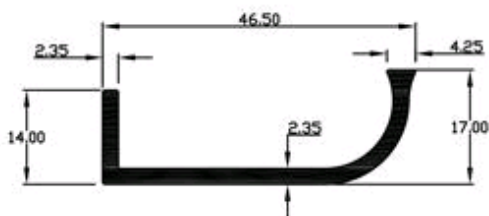

WEIGHT:- 1.585 kg/12'

HARDWARE GROUP

16780

SEC. NO:-16780

N-630

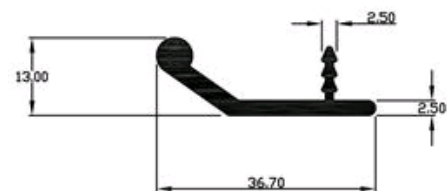

WEIGHT:- 1.330 kg/12'

HARDWARE GROUP

NATIONAL INDUSTRIES

16781

SEC. NO:-16781

N-631

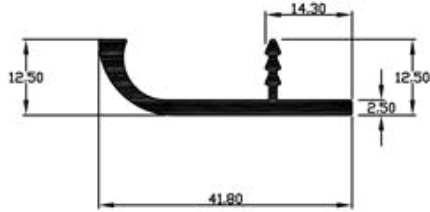

WEIGHT:- 1.373 kg/12'

HARDWARE GROUP

16782

SEC. NO:-16782

N-632

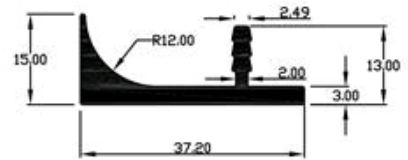

WEIGHT:- 1.758 kg/12'

HARDWARE GROUP

16864

SEC. NO:-16864

N-686
PR

GROUP- SPECIAL
SUB NAME -HARDWARE
PARTY NAME-GENERAL
CO. NAME-N
RELATION-

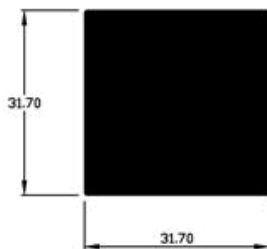

WEIGHT:- 9.928 kg/12'

HARDWARE GROUP

16866

SEC. NO:-16866

N-685
PR

GROUP- SPECIAL
SUB NAME -HARDWARE
PARTY NAME-GENERAL
CO. NAME-N
RELATION-

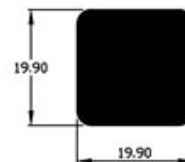

WEIGHT:- 3.860 kg/12'

HARDWARE GROUP

NATIONAL INDUSTRIES

16868

SEC. NO:-16868

N-687
PR

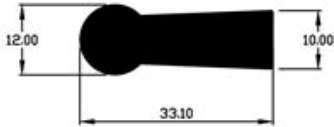

GROUP- SPECIAL
SUB NAME -HARDWARE
PARTY NAME-GENERAL
CO. NAME-N
RELATION-

WEIGHT:- 3.080 kg/12'

HARDWARE GROUP

16869

SEC. NO:-16869

N-688
PR

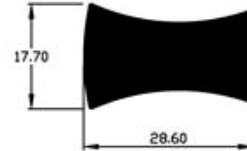

GROUP- SPECIAL
SUB NAME -HARDWARE
PARTY NAME-GENERAL
CO. NAME-N
RELATION-

WEIGHT:- 3.733 kg/12'

HARDWARE GROUP

16870

SEC. NO:-16870

N-689
PR

GROUP- SPECIAL
SUB NAME -HARDWARE
PARTY NAME-GENERAL
CO. NAME-N
RELATION-

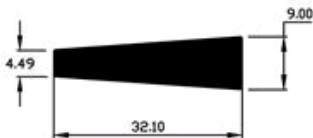

WEIGHT:- 2.159 kg/12'

HARDWARE GROUP

16871

SEC. NO:-16871

N-703
PR

GROUP- SPECIAL
SUB NAME -HARDWARE
PARTY NAME-GENERAL
CO. NAME-N
RELATION-

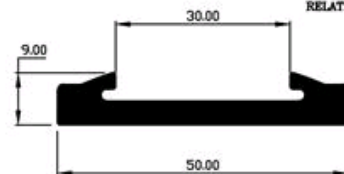

WEIGHT:- 2.647 kg/12'

HARDWARE GROUP

NATIONAL INDUSTRIES

16872

SEC. NO:-16872

N-702
PR

GROUP- SPECIAL
SUB NAME -HARDWARE
PARTY NAME-GENERAL
CO. NAME-N
RELATION-

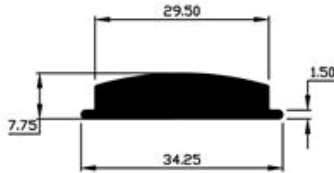

WEIGHT:- 2.119 kg/12'

HARDWARE GROUP

16873

SEC. NO:-16873

N-690
PR

GROUP- SPECIAL
SUB NAME -HARDWARE
PARTY NAME-GENERAL
CO. NAME-N
RELATION-

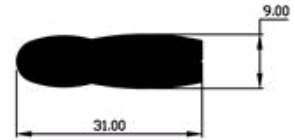

WEIGHT:- 2.436 kg/12'

HARDWARE GROUP