

NATIONAL INDUSTRIES

14696

SEC. NO:-14696

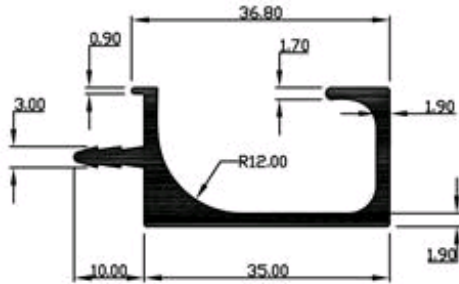

WEIGHT:- 2.066 kg/12'

KITCHEN

15861

SEC. NO:-15861

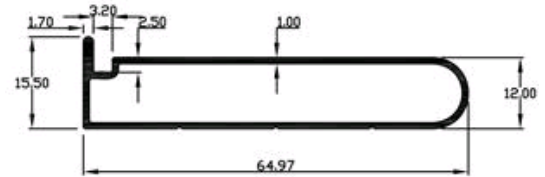

WEIGHT:- 1.524 kg/12'

KITCHEN

15866

SEC. NO:-15866

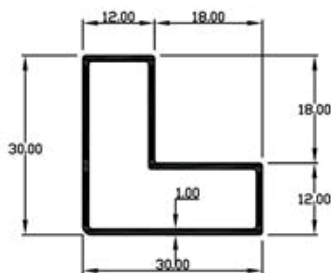

WEIGHT:- 1.142 kg/12'

KITCHEN

15911

SEC. NO:-15911

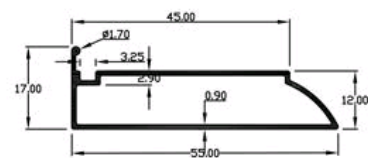

WEIGHT:- 1.200 kg/12'

KITCHEN

NATIONAL INDUSTRIES

15916

SEC. NO:-15916

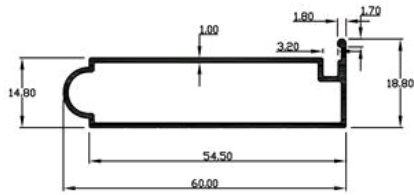

WEIGHT:- 1.500 kg/12'

KITCHEN

15918

SEC. NO:-15918

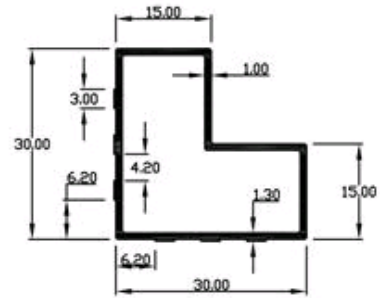

WEIGHT:- 1.200 kg/12'

KITCHEN

15920

SEC. NO:-15920

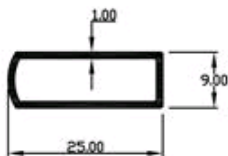

WEIGHT:- 0.600 kg/12'

KITCHEN

15925

SEC. NO:-15925

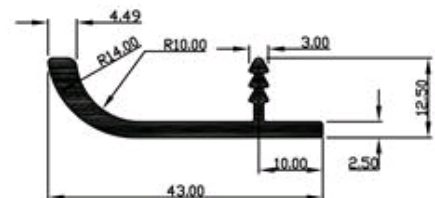

WEIGHT:- 1.500 kg/12'

KITCHEN

NATIONAL INDUSTRIES

15938

SEC. NO:-15938

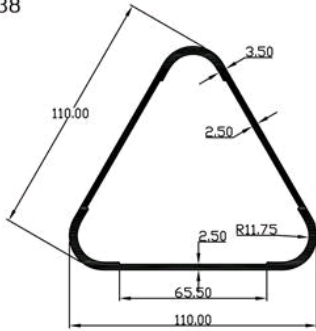

WEIGHT:- 9.240 kg/12'

KITCHEN

15940

SEC. NO:-15940

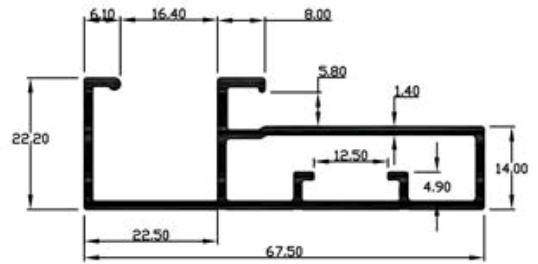

WEIGHT:- 2.640 kg/12'

KITCHEN

15941

SEC. NO:-15941

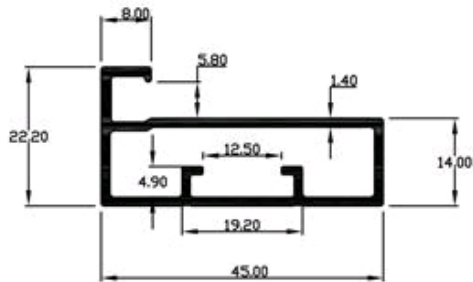

WEIGHT:- 1.971 kg/12'

KITCHEN

15943

SEC. NO:-15943



WEIGHT:- 0.834 kg/12'

KITCHEN

NATIONAL INDUSTRIES

15964

SEC. NO:-15964

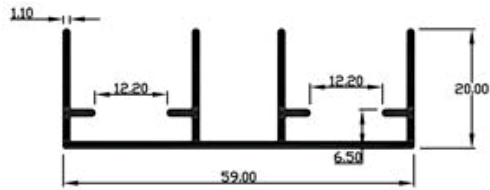

WEIGHT:- 1.640 kg/12'

KITCHEN

15965

SEC. NO:-15965

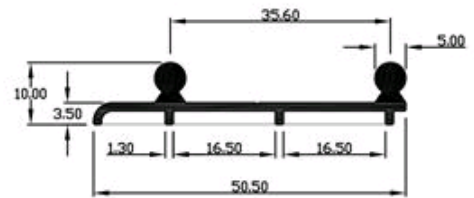

WEIGHT:- 1.260 kg/12'

KITCHEN

15966

SEC. NO:-15966

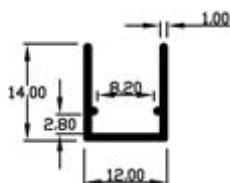

WEIGHT:- 0.390 kg/12'

KITCHEN

15967

SEC. NO:-15967

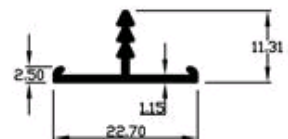

WEIGHT:- 0.456 kg/12'

KITCHEN

NATIONAL INDUSTRIES

15968

SEC. NO:-15968

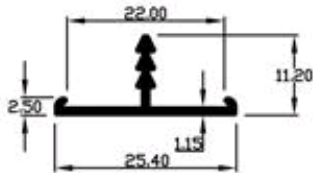

WEIGHT:- 0.485 kg/12'

KITCHEN

15969

SEC. NO:-15969

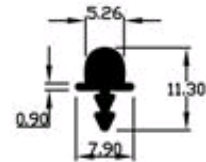

WEIGHT:- 0.390 kg/12'

KITCHEN

15970

SEC. NO:-15970

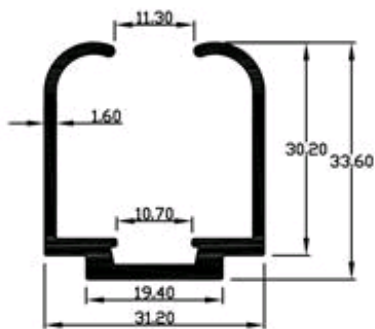

WEIGHT:- 2.020 kg/12'

KITCHEN

15971

SEC. NO:-15971

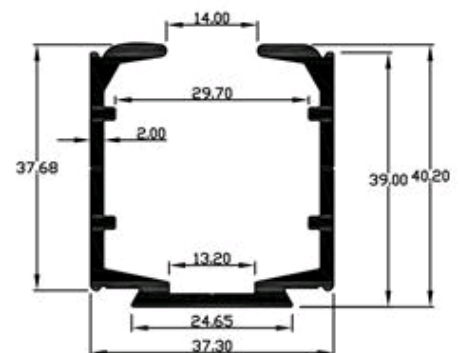

WEIGHT:- 3.006 kg/12'

KITCHEN

NATIONAL INDUSTRIES

15972

SEC. NO:-15972

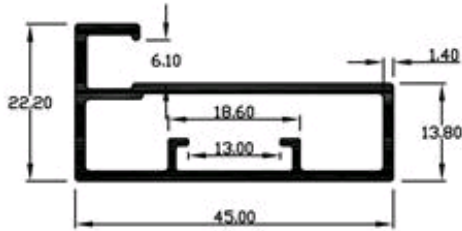

WEIGHT:- 1.945 kg/12'

KITCHEN

15973

SEC. NO:-15973

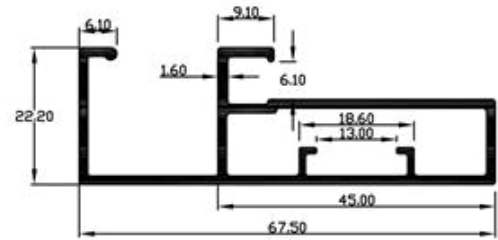

WEIGHT:- 2.616 kg/12'

KITCHEN

15974

SEC. NO:-15974

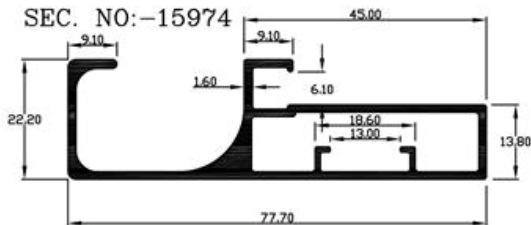

WEIGHT:- 3.195 kg/12'

KITCHEN

15975

SEC. NO:-15975

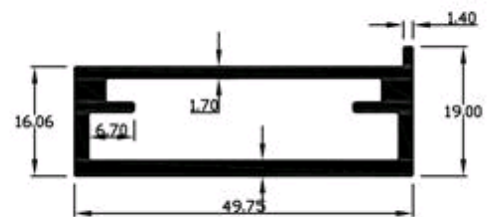

WEIGHT:- 2.878 kg/12'

KITCHEN

NATIONAL INDUSTRIES

15976

SEC. NO:-15976

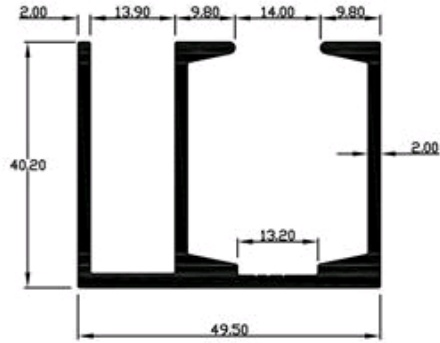

WEIGHT:- 4.088 kg/12'

KITCHEN

15977

SEC. NO:-15977

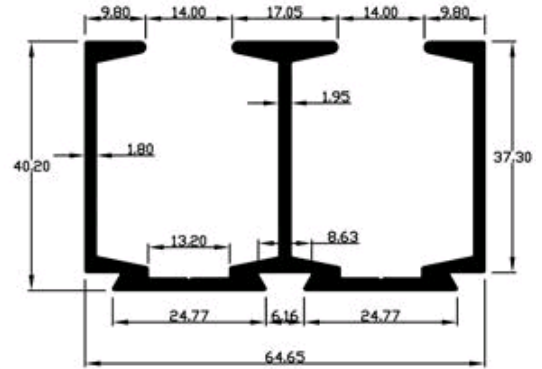

WEIGHT:- 4.472 kg/12'

KITCHEN

15978

SEC. NO:-15978

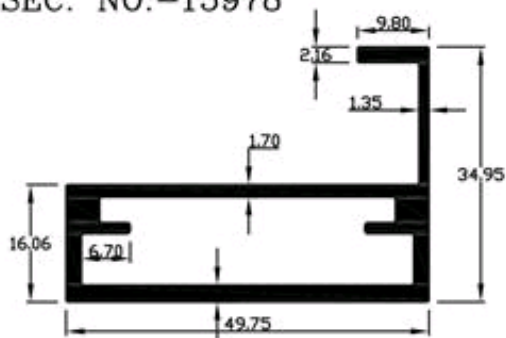

WEIGHT:- 3.270 kg/12'

KITCHEN

15979

SEC. NO:-15979

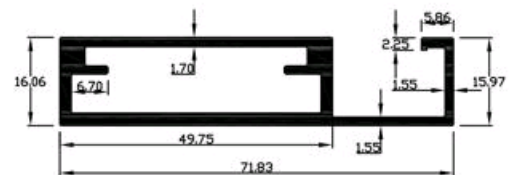

WEIGHT:- 3.478 kg/12'

KITCHEN

NATIONAL INDUSTRIES

15980

SEC. NO:-15980

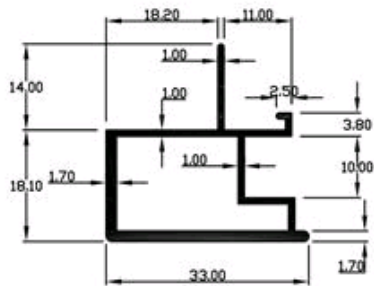

WEIGHT:- 1.517 kg/12'

KITCHEN

15981

SEC. NO:-15981

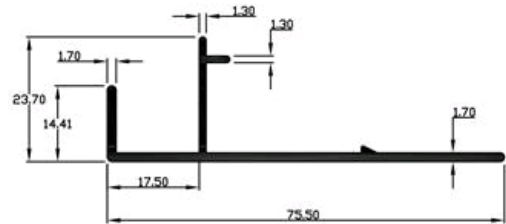

WEIGHT:- 1.832 kg/12'

KITCHEN

15982

SEC. NO:-15982

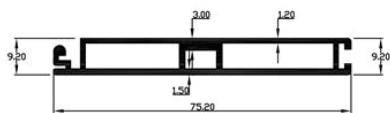

WEIGHT:- 2.583 kg/12'

KITCHEN

15983

SEC. NO:-15983

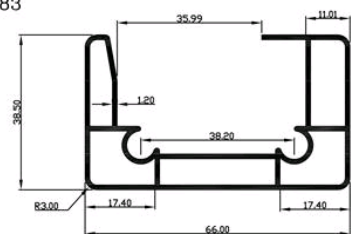

WEIGHT:- 3.644 kg/12'

KITCHEN

NATIONAL INDUSTRIES

16001

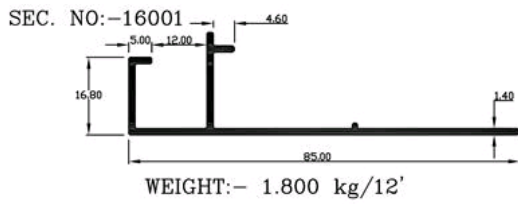

KITCHEN

16002

SEC. NO:-16002

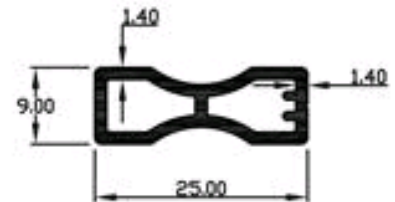

KITCHEN

16003

SEC. NO:-16003

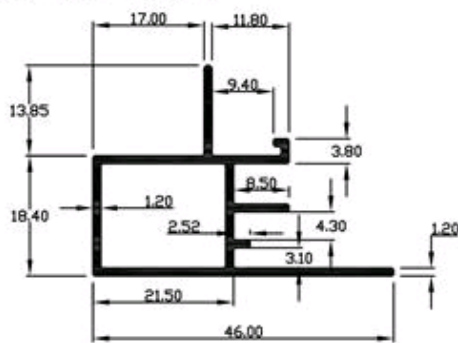

KITCHEN

16049

SEC. NO:-16049

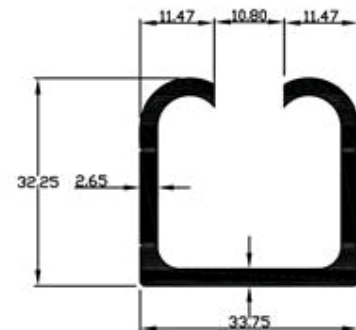

KITCHEN

NATIONAL INDUSTRIES

16072

SEC. NO:-16072

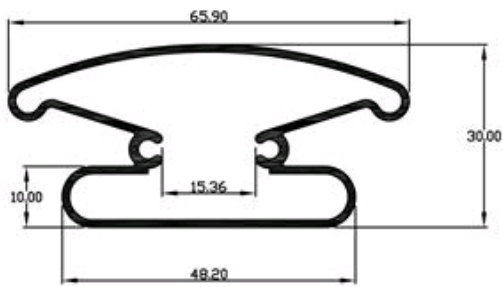

WEIGHT:- 2.750 kg/12'

KITCHEN

16073

SEC. NO:-16073

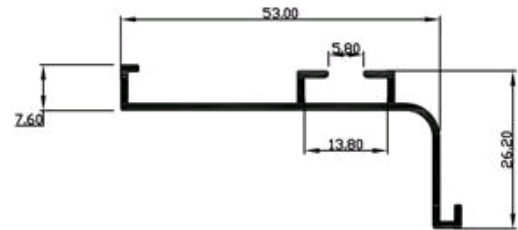

WEIGHT:- 1.225 kg/12'

KITCHEN

16074

SEC. NO:-16074

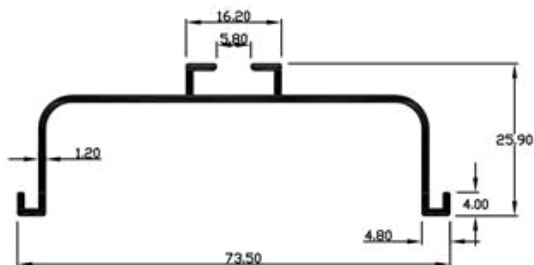

WEIGHT:- 1.560 kg/12'

KITCHEN

16111

SEC. NO:-16111

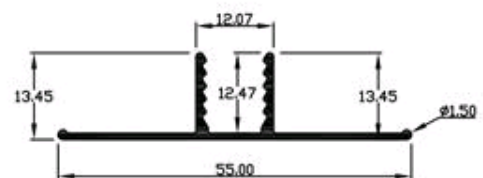

WEIGHT:- 0.880 kg/12'

KITCHEN

NATIONAL INDUSTRIES

16112

SEC. NO:-16112

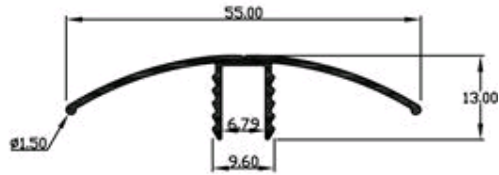

WEIGHT:- 0.867 kg/12'

KITCHEN

16113

SEC. NO:-16113

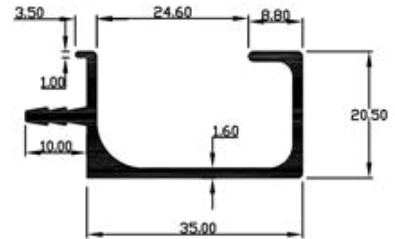

WEIGHT:- 1.700 kg/12'

KITCHEN

16114

SEC. NO:-16114

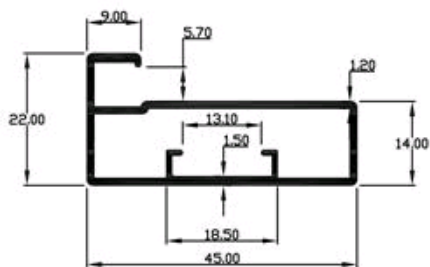

WEIGHT:- 1.740 kg/12'

KITCHEN

16115

SEC. NO:-16115

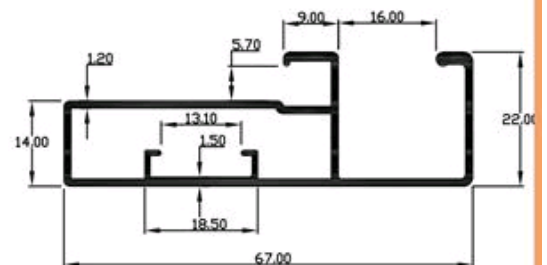

WEIGHT:- 2.350 kg/12'

KITCHEN

NATIONAL INDUSTRIES

16116

SEC. NO:-16116

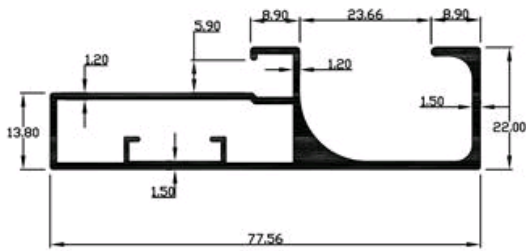

WEIGHT:- 3.000 kg/12'

KITCHEN

16160

SEC. NO:-16160

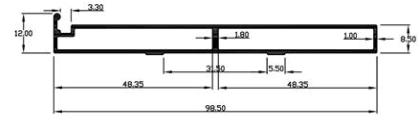

WEIGHT:- 2.330 kg/12'

KITCHEN

16161

SEC. NO:-16161



WEIGHT:- 1.583 kg/12'

KITCHEN

16177

SEC. NO:-16177

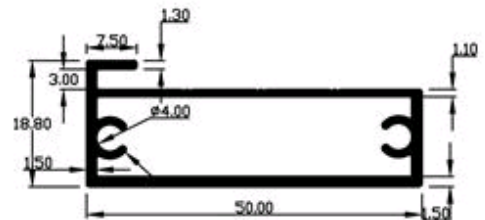

WEIGHT:- 1.991 kg/12'

KITCHEN

NATIONAL INDUSTRIES

16202

SEC. NO:-16202

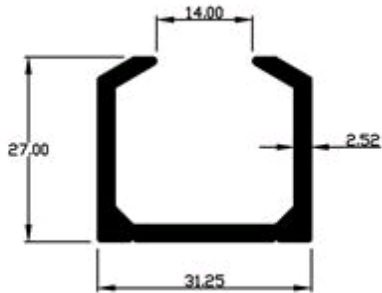

WEIGHT:- 2.233 kg/12'

KITCHEN

16204

SEC. NO:-16204

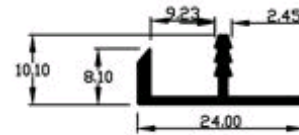

WEIGHT:- 0.550 kg/12'

KITCHEN

16205

SEC. NO:-16205

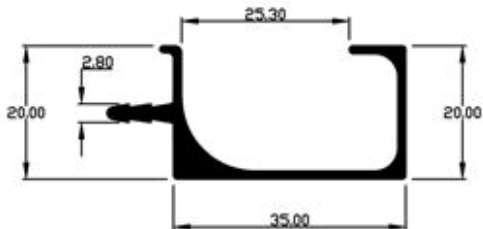

WEIGHT:- 1.494 kg/12'

KITCHEN

16206

SEC. NO:-16206

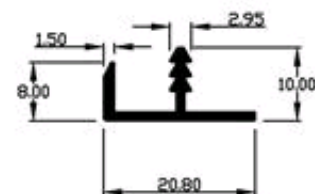

WEIGHT:- 0.492 kg/12'

KITCHEN

NATIONAL INDUSTRIES

16207

SEC. NO:-16207

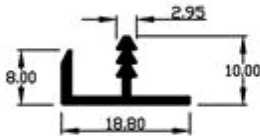

WEIGHT:- 0.469 kg/12'

KITCHEN

16209

SEC. NO:-16209

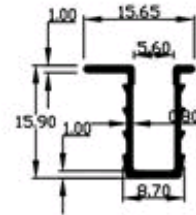

WEIGHT:- 0.436 kg/12'

KITCHEN

16210

SEC. NO:-16210

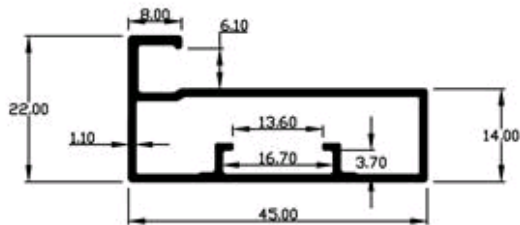

WEIGHT:- 1.580 kg/12'

KITCHEN

16212

SEC. NO:-16212

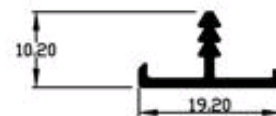

WEIGHT:- 0.413 kg/12'

KITCHEN

NATIONAL INDUSTRIES

16268

SEC. NO:-16268

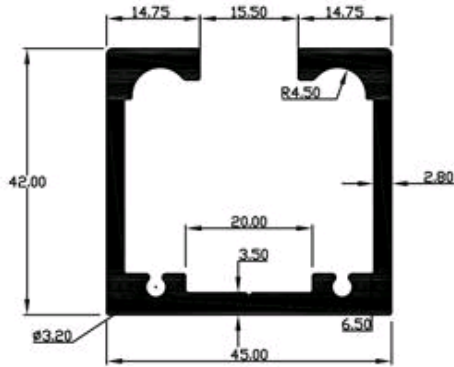

WEIGHT:- 5.122 kg/12'

KITCHEN

16309

SEC. NO:-16309

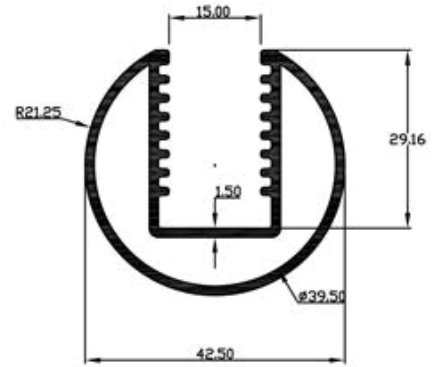

WEIGHT:- 3.140 kg/12'

KITCHEN

16342

SEC. NO:-16342

N-394

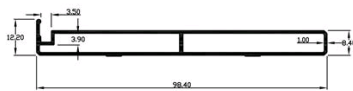

WEIGHT:- 2.257 kg/12'

KITCHEN

16343

SEC. NO:-16343

N-394

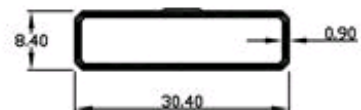

WEIGHT:- 0.657 kg/12'

KITCHEN

NATIONAL INDUSTRIES

16401

SEC. NO:-16401

N-428

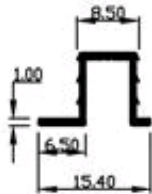

WEIGHT:- 0.300 kg/12'

KITCHEN

16632

SEC. NO:-16632

N-566

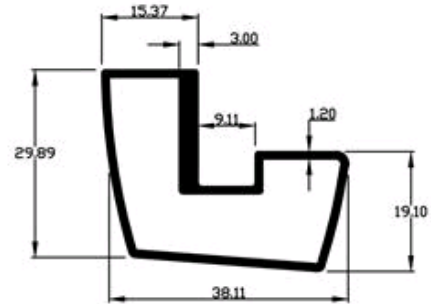

WEIGHT:- 1.975 kg/12'

KITCHEN

16633

SEC. NO:-16633

N-567

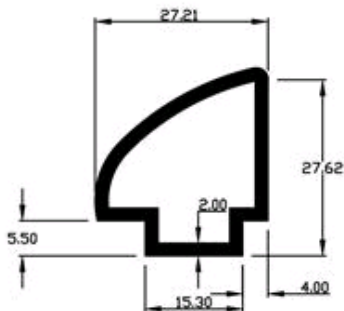

WEIGHT:- 1.860 kg/12'

KITCHEN

16634

SEC. NO:-166634

N-568

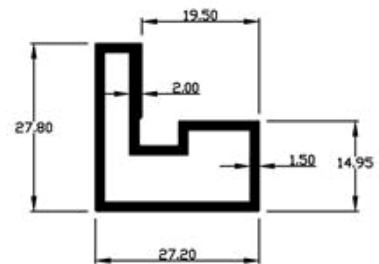

WEIGHT:- 1.727 kg/12'

KITCHEN

NATIONAL INDUSTRIES

16635

SEC. NO:-16635

N-569

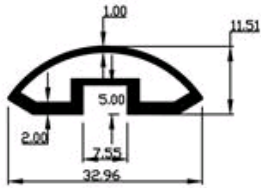

WEIGHT:- 1.081 kg/12'

KITCHEN

16822

SEC. NO:-16822

OLIVE

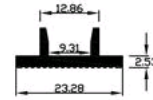

WEIGHT:- 0.753 kg/12'

KITCHEN