

NATIONAL INDUSTRIES

16646

SEC. NO:-16646

N-487

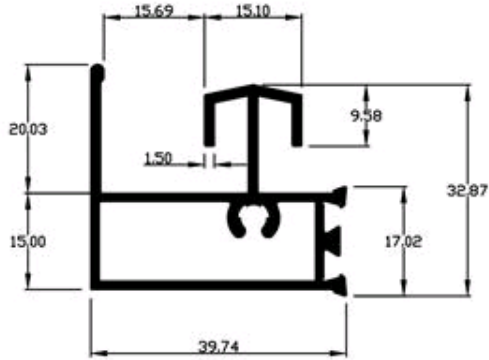

WEIGHT:- 2.656 kg/12'

THERMAL SEC (W)

16647

SEC. NO:-16647

N-488

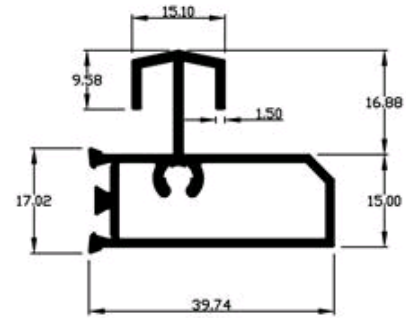

WEIGHT:- 2.322 kg/12'

THERMAL SEC (W)

16648

SEC. NO:-16648

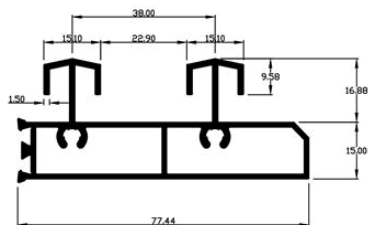

WEIGHT:- 4.325 kg/12'

THERMAL SEC (W)

16649

SEC. NO:-16649

N-490

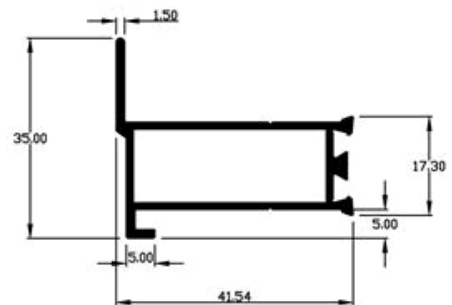

WEIGHT:- 1.776 kg/12'

THERMAL SEC (W)

NATIONAL INDUSTRIES

16650

SEC. NO:-16650

N-491

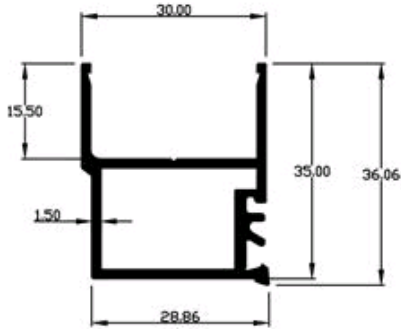

WEIGHT:- 2.003 kg/12'

THERMAL SEC (W)

16651

SEC. NO:-16651

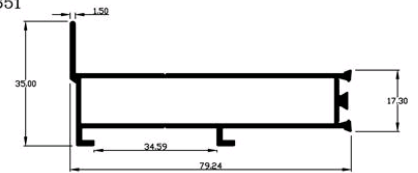

WEIGHT:- 2.796 kg/12'

THERMAL SEC (W)

16652

SEC. NO:-16652

N-493

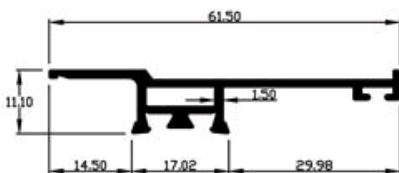

WEIGHT:- 1.472 kg/12'

THERMAL SEC (W)

16653

SEC. NO:-16653

N-494

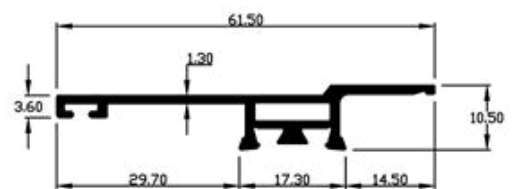

WEIGHT:- 1.421 kg/12'

THERMAL SEC (W)

NATIONAL INDUSTRIES

16654

SEC. NO:-16654

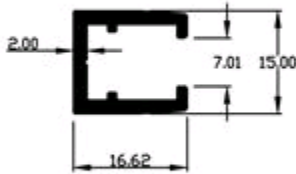

WEIGHT:- 0.924 kg/12'

THERMAL SEC (W)

16655

SEC. NO:-16655

N-

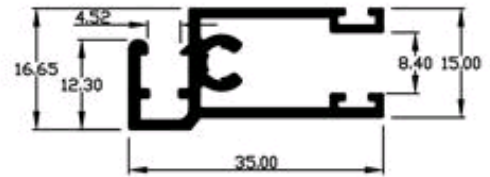

WEIGHT:- 1.528 kg/12'

THERMAL SEC (W)

16656

SEC. NO:-16656

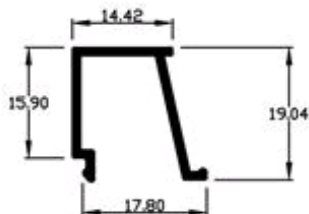

WEIGHT:- 0.660 kg/12'

THERMAL SEC (W)

16657

SEC. NO:-16657

N-

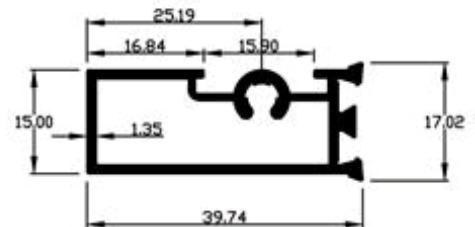

WEIGHT:- 1.700 kg/12'

THERMAL SEC (W)

NATIONAL INDUSTRIES

16658

SEC. NO:-16658

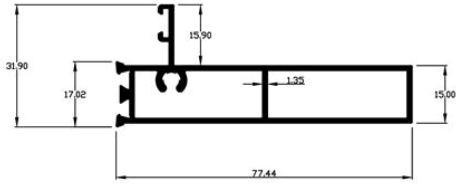

WEIGHT:- 3.126 kg/12'

THERMAL SEC (W)

16659

SEC. NO:-16659

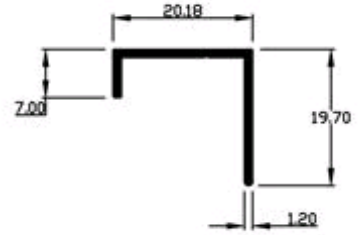

WEIGHT:- 0.525 kg/12'

THERMAL SEC (W)

16660

SEC. NO:-16660

ALD

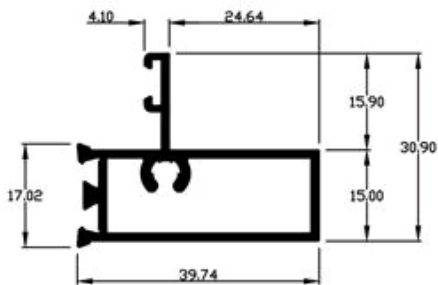

WEIGHT:- 1.990 kg/12'

THERMAL SEC (W)

16661

SEC. NO:-16661

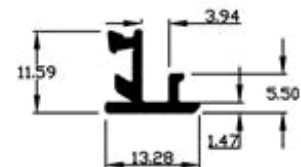

WEIGHT:- 0.487 kg/12'

THERMAL SEC (W)

NATIONAL INDUSTRIES

16662

SEC. NO:-16662

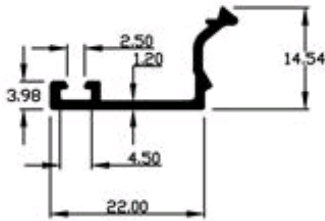

WEIGHT:- 0.568 kg/12'

THERMAL SEC (W)

16663

SEC. NO:-16663

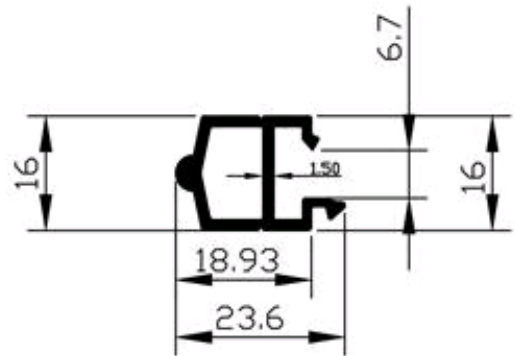

WEIGHT:- 1.077 kg/12'

THERMAL SEC (W)

16664

SEC. NO:-16664

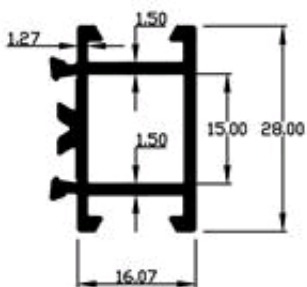

WEIGHT:- 1.587 kg/12'

THERMAL SEC (W)

16665

SEC. NO:-16665

ALD

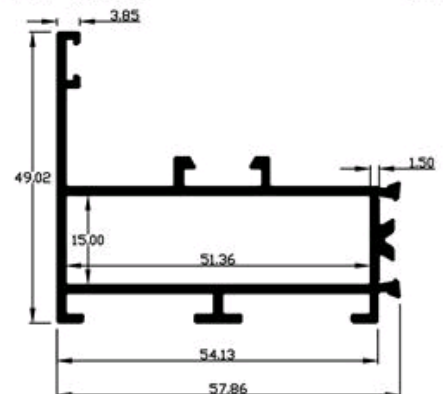

WEIGHT:- 3.370 kg/12'

THERMAL SEC (W)

NATIONAL INDUSTRIES

16666

SEC. NO:-16666

ALD

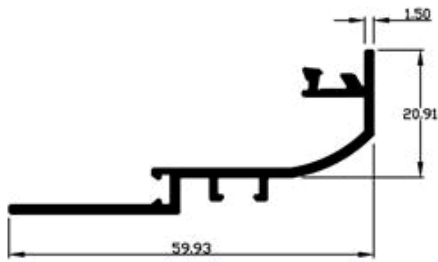

WEIGHT:- 1.600 kg/12'

THERMAL SEC (W)

16667

SEC. NO:-16667

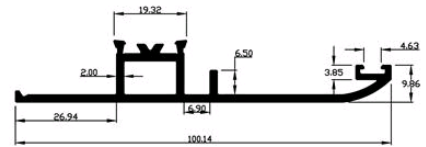

WEIGHT:- 3.292 kg/12'

THERMAL SEC (W)

16668

SEC. NO:-16668

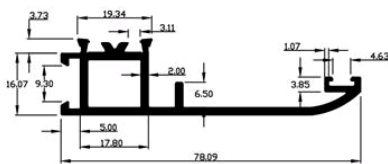

WEIGHT:- 3.082 kg/12'

THERMAL SEC (W)

16669

SEC. NO:-16669

ALD

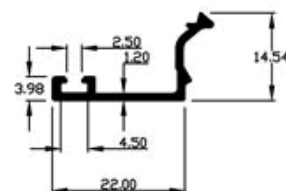

WEIGHT:- 0.568 kg/12'

THERMAL SEC (W)

NATIONAL INDUSTRIES

16670

SEC. NO:-16670

ALD

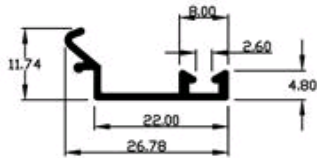

WEIGHT:- 0.522 kg/12'

THERMAL SEC (W)

16671

SEC. NO:-16671

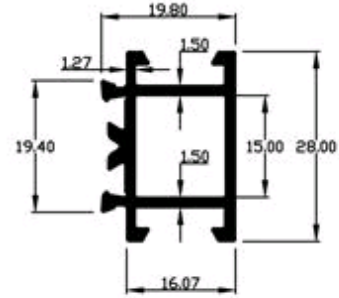

WEIGHT:- 1.587 kg/12'

THERMAL SEC (W)

16672

SEC. NO:-16672

ALD

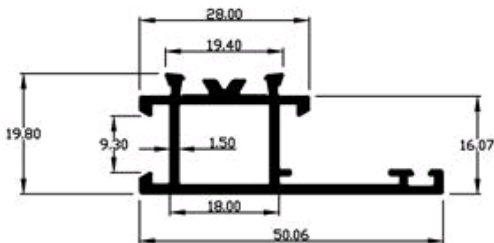

WEIGHT:- 1.987 kg/12'

THERMAL SEC (W)

16673

SEC. NO:-16673

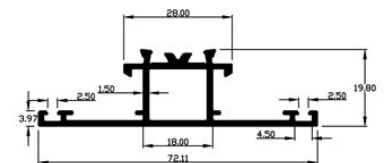

WEIGHT:- 2.387 kg/12'

THERMAL SEC (W)

NATIONAL INDUSTRIES

16674

SEC. NO:-16674

ALD

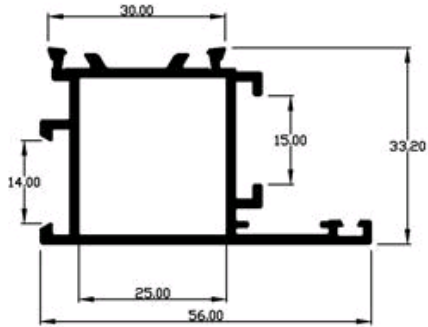

WEIGHT:- 2.818 kg/12'

THERMAL SEC (W)

16675

SEC. NO:-16675

ALD

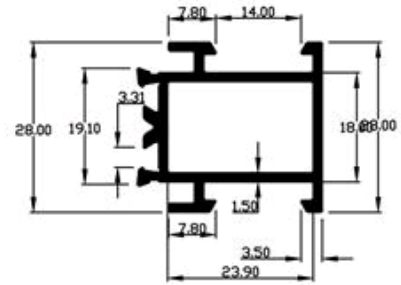

WEIGHT:- 2.044 kg/12'

THERMAL SEC (W)

16676

SEC. NO:-16676

ALD

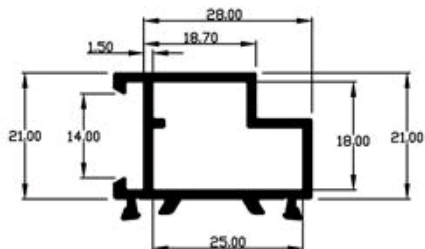

WEIGHT:- 1.856 kg/12'

THERMAL SEC (W)

16677

SEC. NO:-16677

ALD

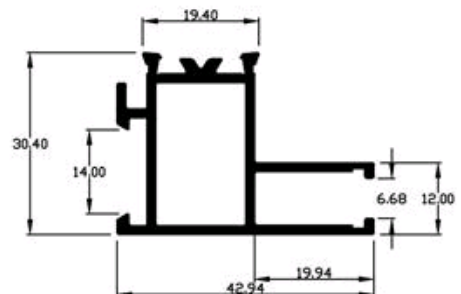

WEIGHT:- 2.391 kg/12'

THERMAL SEC (W)

NATIONAL INDUSTRIES

16678

SEC. NO:-16678

ALD

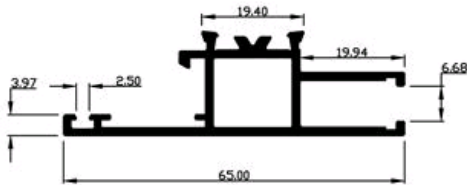

WEIGHT:- 2.405 kg/12'

THERMAL SEC (W)

16679

SEC. NO:-16679

ALD

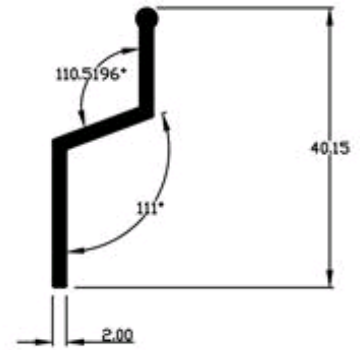

WEIGHT:- 0.985 kg/12'

THERMAL SEC (W)

16680

SEC. NO:-16680

ALD

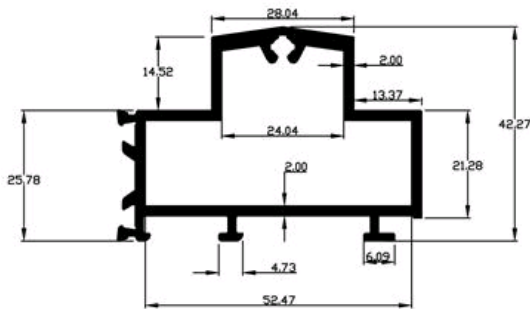

WEIGHT:- 4.434 kg/12'

THERMAL SEC (W)

16681

SEC. NO:-16681

ALD

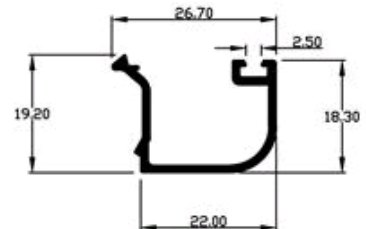

WEIGHT:- 0.827 kg/12'

THERMAL SEC (W)

NATIONAL INDUSTRIES

16682

SEC. NO:-16682 ALD

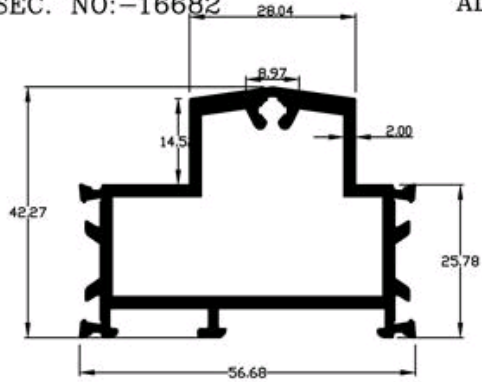

WEIGHT:- 4.359 kg/12'

THERMAL SEC (W)

16683

SEC. NO:-16683 ALD

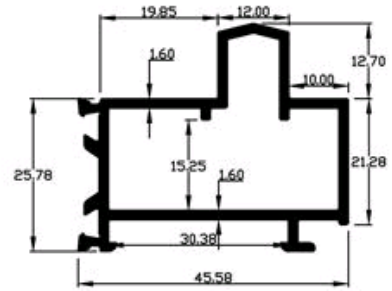

WEIGHT:- 2.809 kg/12'

THERMAL SEC (W)

16684

SEC. NO:-16684

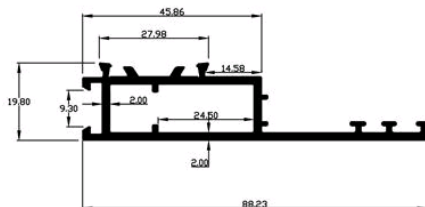

WEIGHT:- 3.670 kg/12'

THERMAL SEC (W)

16685

SEC. NO:-16685

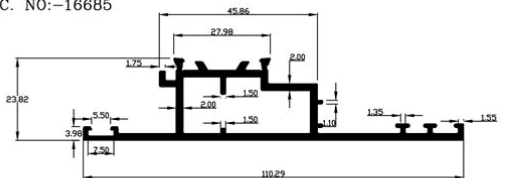

WEIGHT:- 4.357 kg/12'

THERMAL SEC (W)

NATIONAL INDUSTRIES

16686

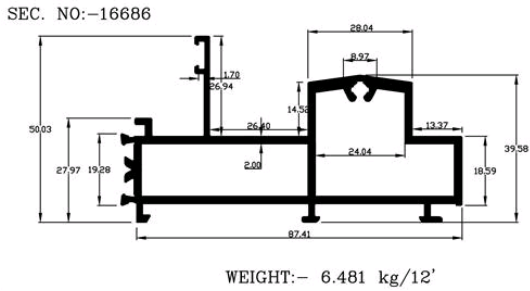

THERMAL SEC (W)

16687

SEC. NO:-16687

ALD

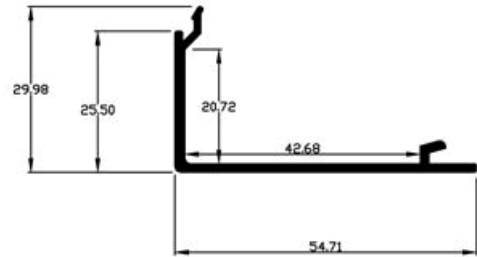

THERMAL SEC (W)

16688

SEC. NO:-16688

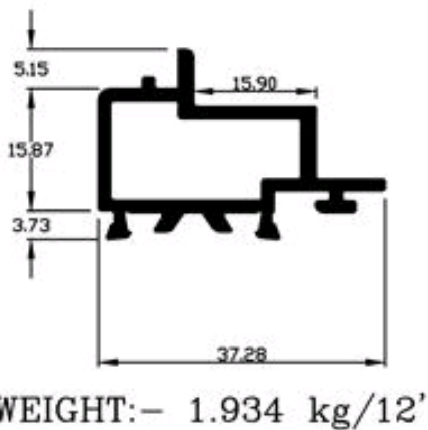

THERMAL SEC (W)

16689

SEC. NO:-16689

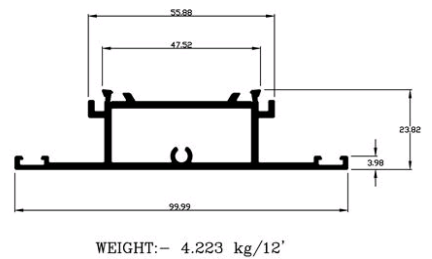

THERMAL SEC (W)

NATIONAL INDUSTRIES

16690

SEC. NO:-16690

ALD

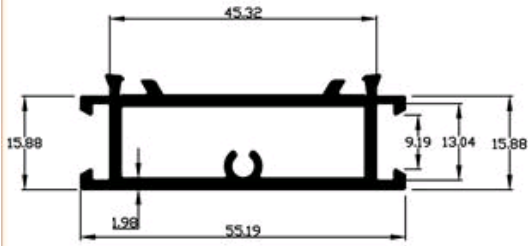

WEIGHT:- 3.005 kg/12'

THERMAL SEC (W)

16691

SEC. NO:-16691

ALD

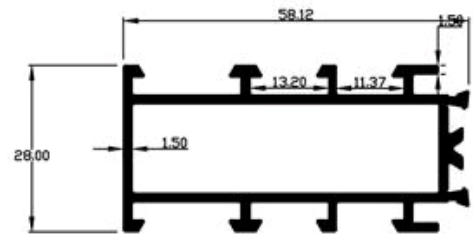

WEIGHT:- 3.335 kg/12'

THERMAL SEC (W)

16692

SEC. NO:-16692

ALD

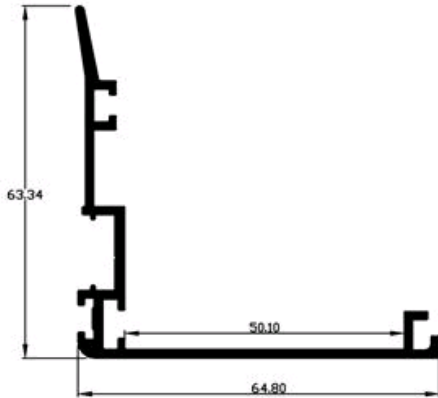

WEIGHT:- 2.692 kg/12'

THERMAL SEC (W)

16693

SEC. NO:-16693

ALD

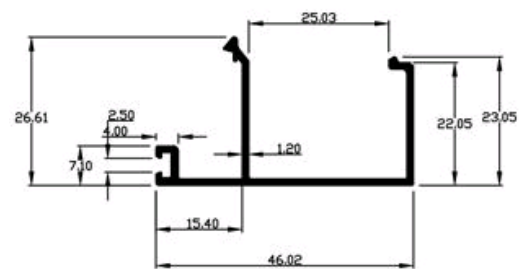

WEIGHT:- 1.303 kg/12'

THERMAL SEC (W)

NATIONAL INDUSTRIES

16694

SEC. NO:-16694

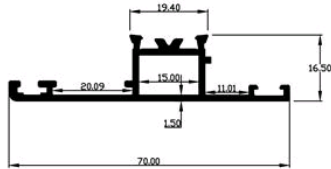

WEIGHT:- 2.145 kg/12'

THERMAL SEC (W)

16695

SEC. NO:-16695

ALD



WEIGHT:- 1.702 kg/12'

THERMAL SEC (W)

16696

SEC. NO:-16696

ALD

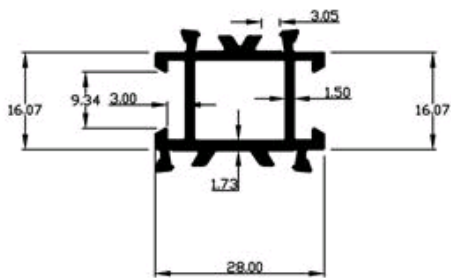

WEIGHT:- 1.894 kg/12'

THERMAL SEC (W)

16697

SEC. NO:-16697

ALD

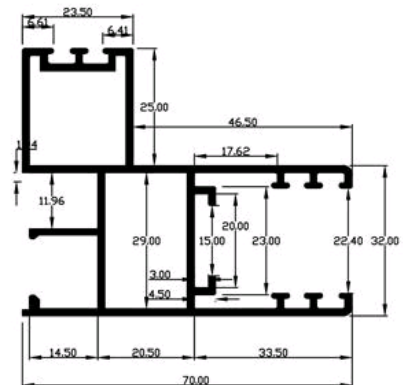

WEIGHT:- 5.020 kg/12'

THERMAL SEC (W)

NATIONAL INDUSTRIES

16698

SEC. NO:-16698

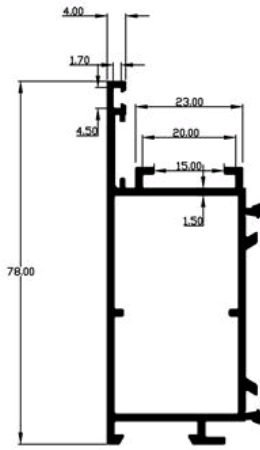

WEIGHT:- 3.535 kg/12'

THERMAL SEC (W)

16699

SEC. NO:-16699

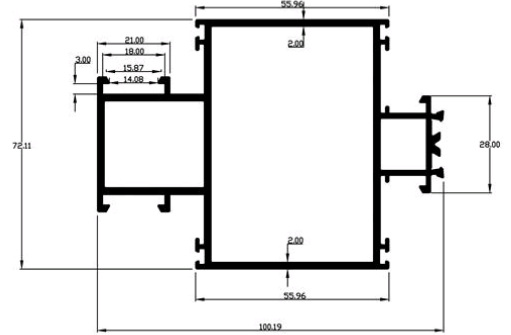

WEIGHT:- 8.345 kg/12'

THERMAL SEC (W)

16700

SEC. NO:-16700

ALD

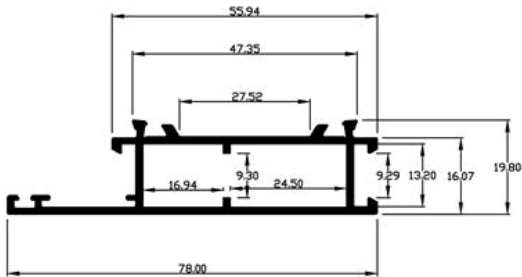

WEIGHT:- 2.872 kg/12'

THERMAL SEC (W)

16701

SEC. NO:-16701

ALD

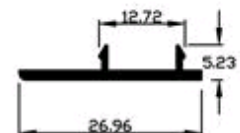

WEIGHT:- 0.445 kg/12'

THERMAL SEC (W)

NATIONAL INDUSTRIES

16702

SEC. NO:-16702

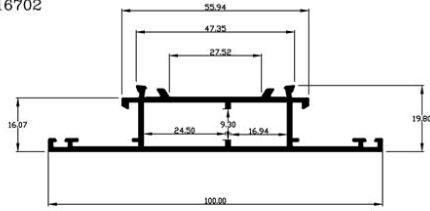

WEIGHT:- 3.270 kg/12'

THERMAL SEC (W)

16703

SEC. NO:-16703

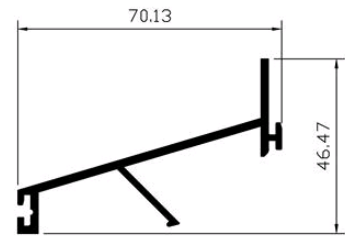

WEIGHT:- 2.632 kg/12'

THERMAL SEC (W)