

# NATIONAL INDUSTRIES

## 11901

**3/4" TWO TRACK TOP**

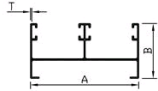

SEC.No.	A	B	T	Wt.(kg/Mtr.)	Wt.(kg/12')
11901	61.85	31.75	0.65	0.327	1,200-1,400
11902	61.85	31.75	0.75	0.382	1,400-1,600
11903	61.85	31.75	0.84	0.437	1,600-1,800
11904	61.85	31.75	0.94	0.491	1,800-2,000
11905	61.85	31.75	1.04	0.546	2,000-2,200
11906	61.85	31.75	1.14	0.601	2,200-2,500
11907	61.85	31.75	1.40	0.737	2,700-2,900

## 3/4 SERIES ( W )

## 11921

**3/4" TWO TRACK BOTTOM**

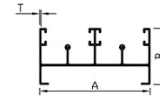

SEC.No.	A	B	T	Wt.(kg/Mtr.)	Wt.(kg/12')
11921	61.85	31.75	0.65	0.409	1,500-1,700
11922	61.85	31.75	0.85	0.464	1,700-1,900
11923	61.85	31.75	1.00	0.546	2,000-2,200
11924	61.85	31.75	1.10	0.600	2,200-2,500
11925	61.85	31.75	1.55	0.846	3,100-3,400

## 3/4 SERIES ( W )

## 11941

**3/4" THREE TRACK TOP**

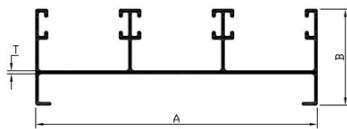

SEC.No.	A	B	T	Wt.(kg/Mtr.)	Wt.(kg/12')
11941	92.00	31.50	0.65	0.491	1,800-2,000
11942	92.00	31.50	0.72	0.546	2,000-2,200
11943	92.00	31.50	0.87	0.655	2,400-2,600
11944	92.00	31.50	0.98	0.737	2,700-3,000
11945	92.00	31.50	1.30	0.933	3,400-3,600
11946	92.00	31.50	1.50	1.020	3,700-3,900

## 3/4 SERIES ( W )

## 11961

**3/4" THREE TRACK BOTTOM**

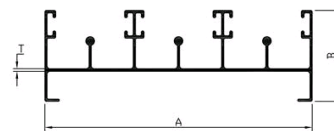

SEC.No.	A	B	T	Wt.(kg/Mtr.)	Wt.(kg/12')
11961	92.00	31.50	0.77	0.601	2,200-2,500
11962	92.00	31.50	0.89	0.765	2,800-3,000
11963	92.00	31.50	1.10	0.911	3,200-3,400
11964	92.00	31.50	1.30	1.070	3,900-4,100
11965	92.00	31.50	1.50	1.248	4,500-4,700

## 3/4 SERIES ( W )

# NATIONAL INDUSTRIES

## 11981

### 3/4" FOUR TRACK TOP

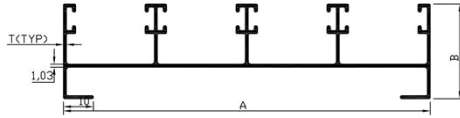

SEC.No.	A	B	T	Wt.(kg/Mtr.)	Wt.(kg/12')
11981	122.40	31.50	0.97	0.901	3.300-3.600
11982	122.40	31.50	1.30	1.142	4.180-4.500
11983	122.40	31.50	1.50	1.585	4.800-5.100

## 3/4 SERIES ( W )

## 11991

### 3/4" FOUR TRACK BOTTOM

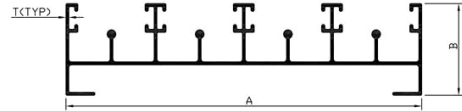

SEC.No.	A	B	T	Wt.(kg/Mtr.)	Wt.(kg/12')
11991	122.40	31.50	1.00	0.928	4.000-4.500
11992	122.40	31.50	1.30	1.321	4.800-5.200
11993	122.40	31.50	1.50	1.580	5.800-6.200

## 3/4 SERIES ( W )

## 11996

### 3/4"FOUR TRACK BOTTOM

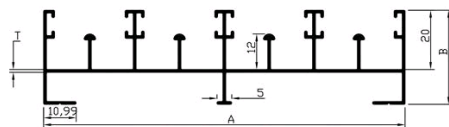

SEC.No.	A	B	T	Wt.(kg/Mtr.)	Wt.(kg/12')
11996	122.40	31.50	1.00	0.928	3.850-4.200
11997	122.40	31.50	1.30	1.377	5.000-5.400
11998	122.40	31.50	1.50	1.580	5.800-6.200

## 3/4 SERIES ( W )

## 12001

### 3/4" TWO TRACK BOTTOM (UMBRELLA)

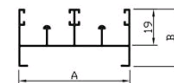

SEC.No.	A	B	T	Wt.(kg/Mtr.)	Wt.(kg/12')
12001	61.85	31.75	0.75	0.327	1.500-1.700
12002	61.85	31.75	0.85	0.409	1.700-1.900
12003	61.85	31.75	0.97	0.491	1.900-2.100
12004	61.85	31.75	1.03	0.599	2.100-2.400
12005	61.85	31.75	1.15	0.656	2.400-2.600
12006	61.85	31.75	1.40	0.850	3.000-3.300

## 3/4 SERIES ( W )

# NATIONAL INDUSTRIES

## 12021

### 3/4" THREE TRACK BOTTOM (UMBRELLA)

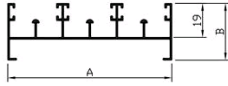

SEC.No.	A	B	T	Wt.(kg/Mtr.)	Wt.(kg/12')
12021	92.00	31.75	0.70	0.683	2.500-2.700
12022	92.00	31.75	0.80	0.737	2.700-2.900
12023	92.00	31.75	0.94	0.819	3.000-3.300
12024	92.00	31.75	1.04	0.901	3.300-3.600
12025	92.00	31.75	1.32	1.145	4.200-4.500

## 3/4 SERIES ( W )

## 12041

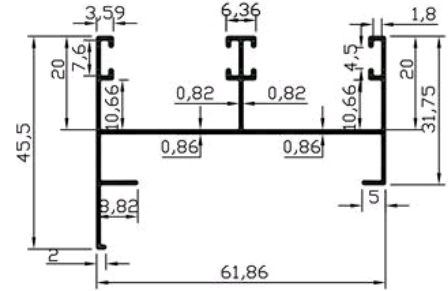

AREA:- 173.773 Sqmm<sup>^</sup>  
WEIGHT:- 1.717 kg/12'

## 3/4 SERIES ( W )

## 12061

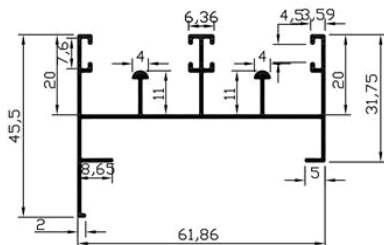

AREA:- 201.398 Sqmm<sup>^</sup>  
WEIGHT:- 2.000 kg/12'

## 3/4 SERIES ( W )

## 12081

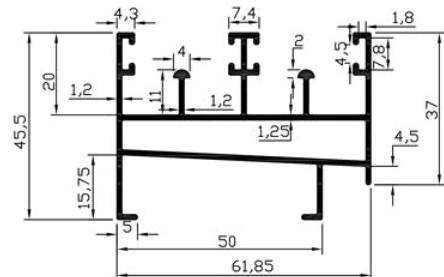

WEIGHT:- 3.700-3.900 kg/12'

## 3/4 SERIES ( W )

# NATIONAL INDUSTRIES

## 12101

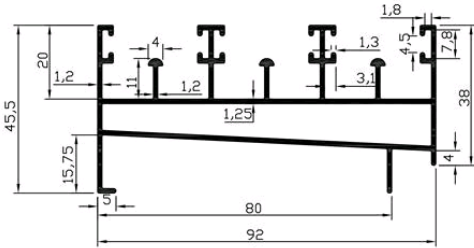

WEIGHT:- 5.000-5.400 kg/12'

## 3/4 SERIES ( W )

## 12121

### 3/4" HANDLE

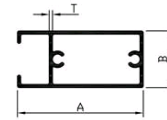

SEC.No.	A	B	T	Wt.(kg/Mtr.)	Wt.(kg/12')
12121	40.00	18.00	0.60	0.219	0.800-0.900
12122	40.00	18.00	0.79	0.273	1.000-1.200
12123	40.00	18.00	0.92	0.328	1.200-1.400
12124	40.00	18.00	1.12	0.382	1.400-1.600
12125	40.00	18.00	1.30	0.437	1.600-1.750
12126	40.00	18.00	1.50	0.491	1.800-1.950
12127	60.00	18.00	0.75	0.355	1.300-1.400

## 3/4 SERIES ( W )

## 12141

### 3/4" INTERLOCK

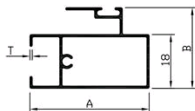

SEC.No.	A	B	T	Wt.(kg/Mtr.)	Wt.(kg/12')
12141	40.00	27.00	0.70	0.245	1.100-1.200
12142	40.00	27.00	0.79	0.327	1.200-1.400
12143	40.00	27.00	0.95	0.328	1.400-1.550
12144	40.00	27.00	1.11	0.409	1.550-1.700
12145	40.00	27.00	1.30	0.464	1.700-1.850
12146	40.00	27.00	1.50	0.546	2.000-2.200
12147	60.00	27.00	0.80	0.409	1.500-1.650

## 3/4 SERIES ( W )

## 12161

### 3/4" TOP BOTTOM

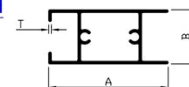

SEC.No.	A	B	T	Wt.(kg/Mtr.)	Wt.(kg/12')
12161	40.00	18.00	0.60	0.219	0.800-0.900
12162	40.00	18.00	0.73	0.273	1.000-1.200
12163	40.00	18.00	0.93	0.328	1.200-1.400
12164	40.00	18.00	1.12	0.382	1.400-1.600
12165	40.00	18.00	1.30	0.437	1.600-1.750
12166	40.00	18.00	1.5	0.491	1.800-1.950

## 3/4 SERIES ( W )

# NATIONAL INDUSTRIES

**12181**

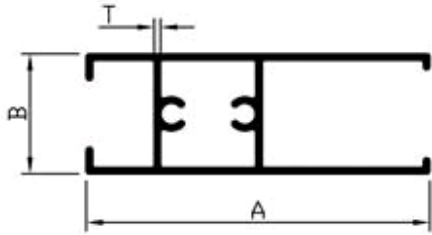

**3/4 SERIES ( W )**

**12201**

**MATTING**

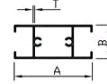

SEC.No.	A	B	T	Wt.(kg/12')
12201	52.00	18.00	0.78	1.200-1.500
12202	42.00	18.00	1.16	1.500-1.700
12203	50.00	25.00	0.85	1.600-1.800
12204	50.00	25.00	1.40	2.500-2.700

**3/4 SERIES ( W )**

**12221**

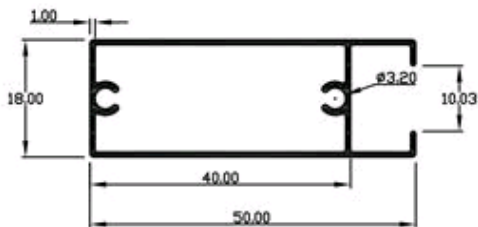

WEIGHT:- 1.500-1.600 kg/12'

**3/4 SERIES ( W )**

**12226**

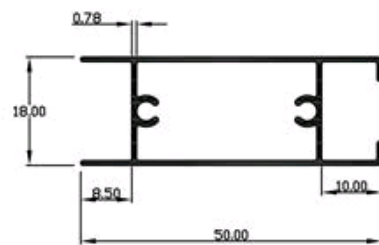

WEIGHT:- 1.100-1.400 kg/12'

**3/4 SERIES ( W )**

# NATIONAL INDUSTRIES

12231

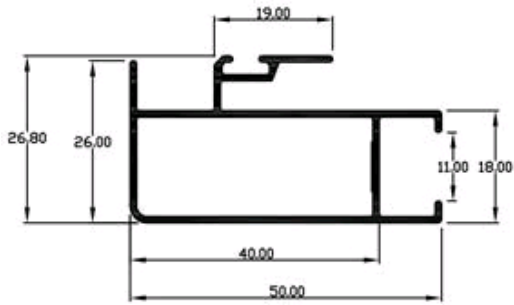

WEIGHT:- 1.800-2.000 kg/12'

3/4 SERIES ( W )

12236

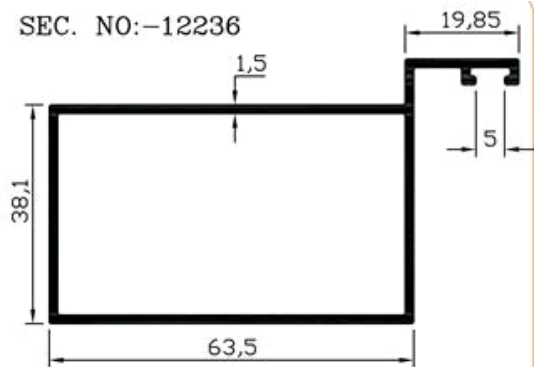

WEIGHT:- 3.400-3.700 kg/12'

3/4 SERIES ( W )

12241

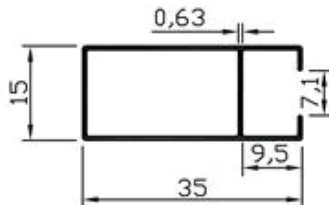

WEIGHT:- 0.650-0.850 kg/12'

3/4 SERIES ( W )

12242

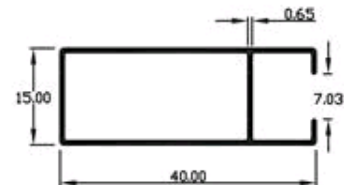

WEIGHT:- 0.730-0.900 kg/12'

3/4 SERIES ( W )

# NATIONAL INDUSTRIES

12243

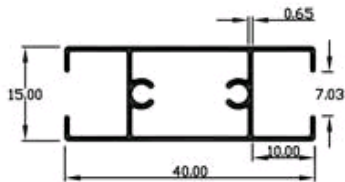

WEIGHT:- 0.900-1.100 kg/12'

3/4 SERIES ( W )

12251

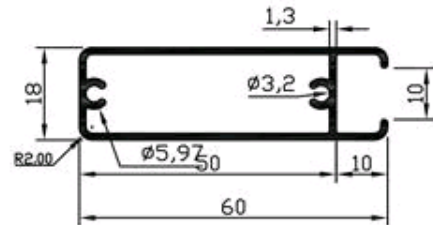

WEIGHT:- 2.100-2.400 kg/12'

3/4 SERIES ( W )

12256

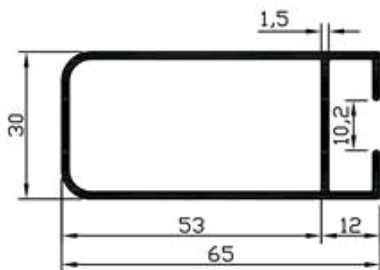

WEIGHT:- 2.900-3.200 kg/12'

3/4 SERIES ( W )

12261

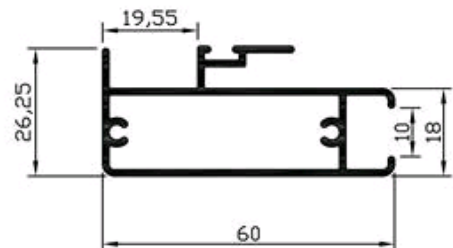

WEIGHT:- 2.700-3.00 kg/12'

3/4 SERIES ( W )

# NATIONAL INDUSTRIES

12266

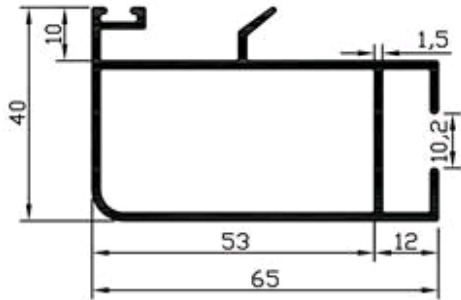

WEIGHT:- 3.400-3.700 kg/12'

3/4 SERIES ( W )

12271

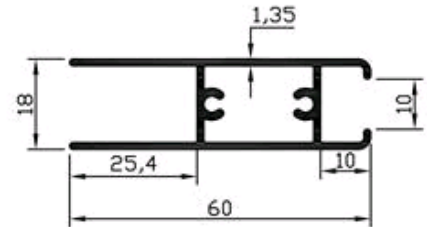

WEIGHT:- 2.300-2.600 kg/12'

3/4 SERIES ( W )

12276

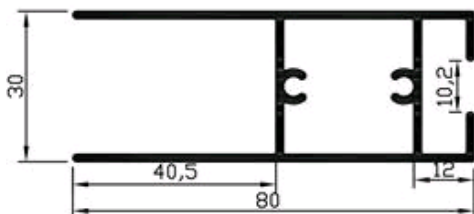

WEIGHT:- 3.700-4.000 kg/12'

3/4 SERIES ( W )

12281

1" HANDLE

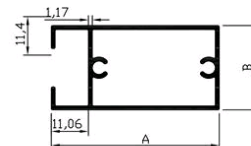

SEC.No.	A	B	T	Wt.(kg/Mtr.)	Wt.(kg/12')
12281	50.00	25.00	0.85	0.420	1.500-1.700
12282	50.00	25.00	1.20	0.593	2.100-2.300
12283	50.00	25.00	1.30	0.617	2.260-2.400
12284	50.00	25.00	1.40	0.655	2.400-2.600
12285	50.00	25.00	1.50	0.717	2.600-2.800

1" SERIESE ( W )



# NATIONAL INDUSTRIES

## 12301

### 1" INTERLOCK

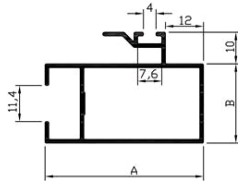

SEC.No.	A	B	T	Wt.(kg/Mtr.)	Wt.(kg/12')
12301	50.00	25.00	1.20	0.633	2.300-2.400
12302	50.00	25.00	1.30	0.683	2.400-2.600
12303	50.00	25.00	1.50	0.788	2.800-3.100

## 1" SERIESE (W)

## 12321

### 1" TWO TRACK TOP

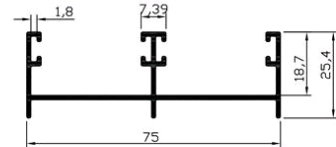

SEC.No.	T	Wt.(kg/Mtr.)	Wt.(kg/12')
12321	1.30	0.619	2.200-2.400
12322	1.70	0.800	2.900-3.100

## 1" SERIESE (W)

## 12341

### 1" TWO TRACK BOTTOM

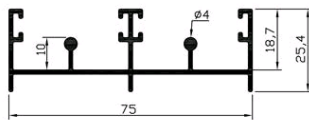

SEC.No.	T	Wt.(kg/Mtr.)	Wt.(kg/12')
12341	1.25	0.676	2.400-2.600
12342	1.60	0.819	3.000-3.200

## 1" SERIESE (W)

## 12351

### 1" BOTTOM HOLLOW

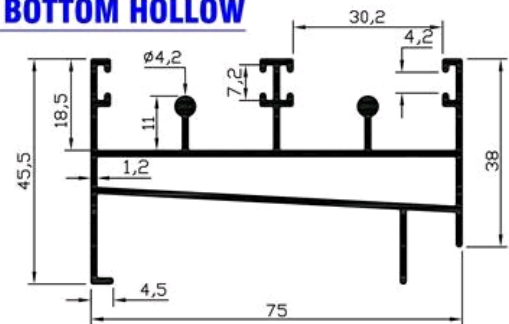

WEIGHT: 4.000-4.300 kg/12'

## 1" SERIESE (W)

# NATIONAL INDUSTRIES

## 12361

### 1" THREE TRACK TOP

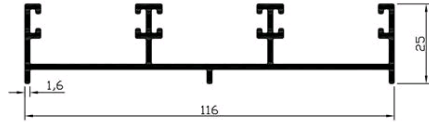

SEC.No.	T	Wt.(kg/Mtr.)	Wt.(kg/12')
12361	1.20	0.860	3.150-3.500
12362	1.30	0.969	3.500-3.700
12363	1.40	1.005	3.700-4.000
12364	1.60	1.200	4.300-4.600

## 1" SERIESE (W)

## 12381

### 1" THREE TRACK BOTTOM

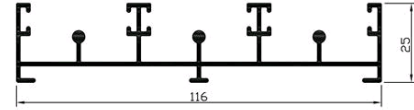

SEC.No.	T	Wt.(kg/Mtr.)	Wt.(kg/12')
12381	1.15	0.956	3.500-3.800
12382	1.35	1.170	4.000-4.200
12383	1.50	1.300	4.700-5.000

## 1" SERIESE (W)

## 12401

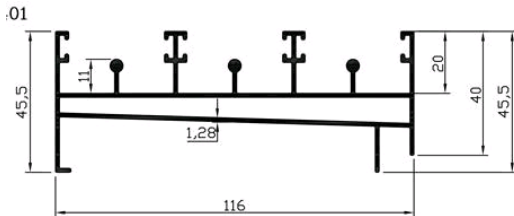

WEIGHT: 5.800-6.200 kg/12'

## 1" SERIESE (W)

## 12406

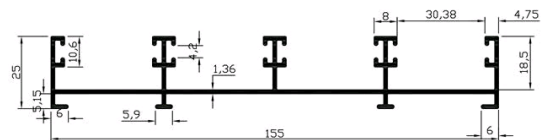

WEIGHT: 4.800-5.200 kg/12'

## 1" SERIESE (W)

# NATIONAL INDUSTRIES

## 12411

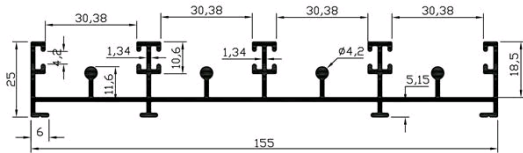

WEIGHT: 5.700-6.200 kg/12'

## 1" SERIESE (W)

## 12416

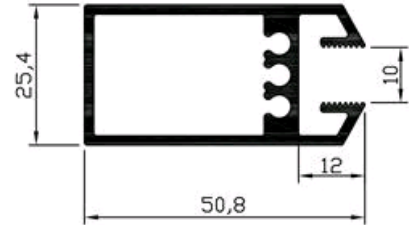

WEIGHT: 3.300-3.500 kg/12'

## 1" SERIESE (W)

## 12421

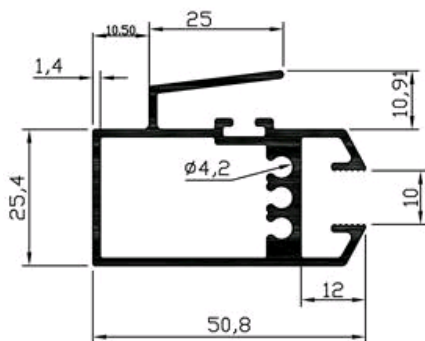

WEIGHT: 3.900-4.200 kg/12'

## 1" SERIESE (W)

## 12426

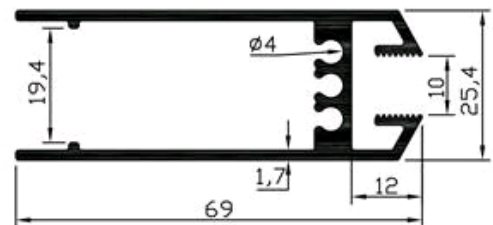

WEIGHT: 3.800-4.200 kg/12'

## 1" SERIESE (W)

# NATIONAL INDUSTRIES

**12436**

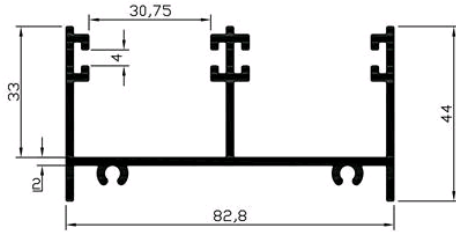

WEIGHT: 5.000-5.400 kg/12'

**33 MM INDIAN SERIES (W)**

**12441**

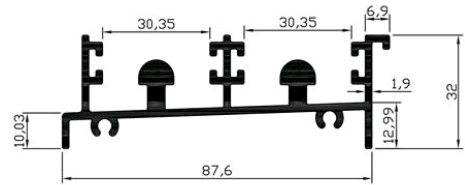

WEIGHT: 6.400-6.800 kg/12'

**33 MM INDIAN SERIES (W)**

**12446**

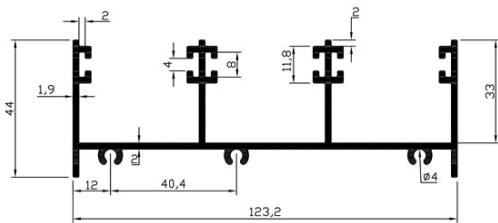

WEIGHT: 7.000-7.500 kg/12'

**33 MM INDIAN SERIES (W)**

**12451**

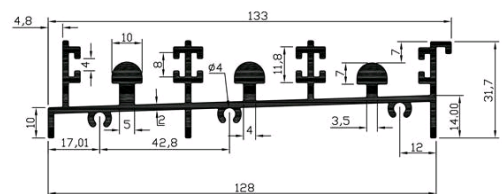

WEIGHT: 9.000-9.500 kg/12'

**33 MM INDIAN SERIES (W)**

# NATIONAL INDUSTRIES

## 12601

### SINTEX-'A'

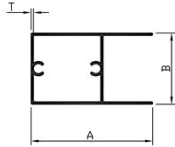

SEC.No.	A	B	T	Wt.(kg/Mtr.)	Wt.(kg/12')
12601	40.00	23.60	0.61	0.218	0.900-1.050
12602	40.00	23.60	0.75	0.286	1.050-1.200

## 3/4 SERIES ( W )

## 12621

### SINTEX-'H'

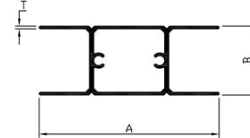

SEC.No.	A	B	T	Wt.(kg/Mtr.)	Wt.(kg/12')
12621	60.00	23.60	0.84	0.273	1.500-1.700

## 3/4 SERIES ( W )

## 13021

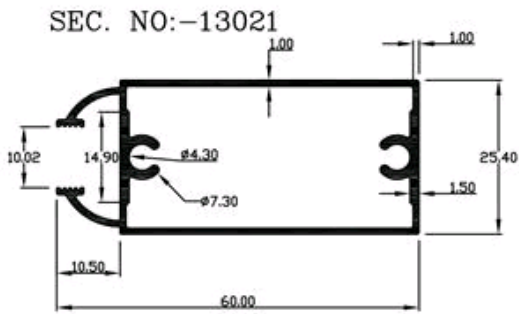

WEIGHT:- 2.100-2.400 kg/12'

## 1" SERIESE (W)

## 13022

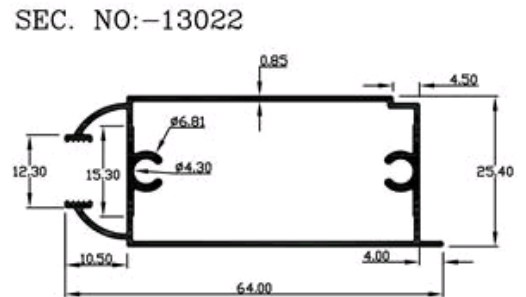

WEIGHT:- 1.860 kg/12'

## 1" SERIESE (W)

# NATIONAL INDUSTRIES

## 13023

SEC. NO:--13023

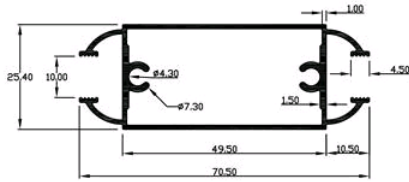

WEIGHT:- 2.400-2.600 kg/12'

## 1" SERIESE (W)

## 13029

SEC. NO:--13029

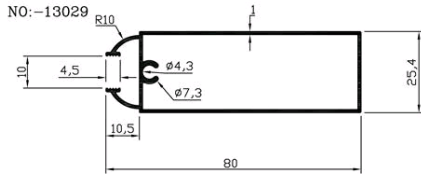

WEIGHT:- 2.300-2.500 kg/12'

## 1" SERIESE (W)

## 13031

SEC. NO:--13031

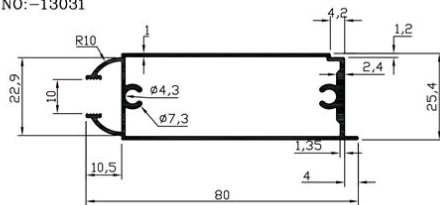

WEIGHT:- 2.650-2.900 kg/12'

## 1" SERIESE (W)

## 13034

SEC. NO:--13034

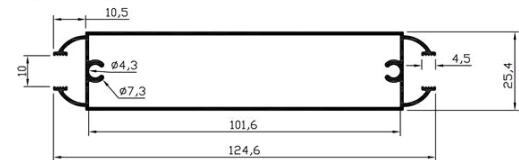

WEIGHT:- 3.400-3.700 kg/12'

## 1" SERIESE (W)

# NATIONAL INDUSTRIES

**14551**

SEC. NO:-14551

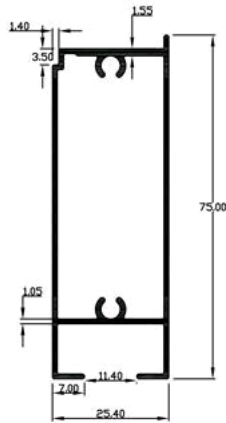

WEIGHT:- 2.475 kg/12'

**1" SERIESE (W)**

**14556**

SEC. NO:-14556

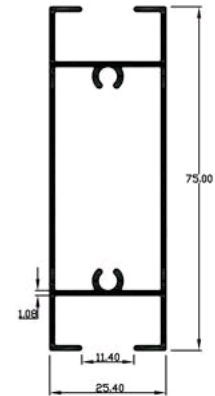

WEIGHT:- 2.600 kg/12'

**1" SERIESE (W)**

**14601**

SEC. NO:-14601

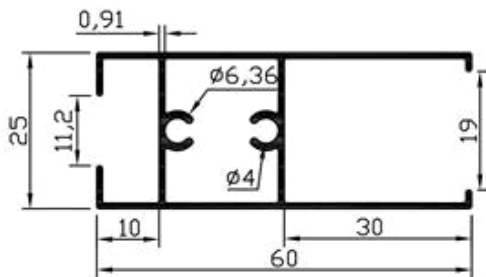

WEIGHT:- 1.877 kg/12'

**1" SERIESE (W)**

**14861**

SEC. NO:-14861

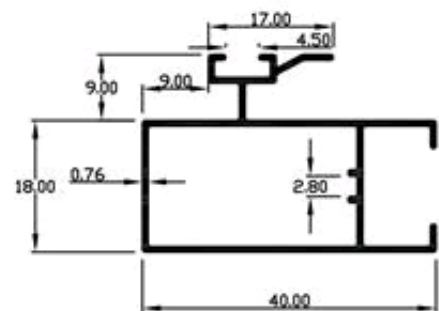

WEIGHT:- 1.154 kg/12'

**3/4 SERIES ( W)**

# NATIONAL INDUSTRIES

## 14991

SEC. NO:-14991

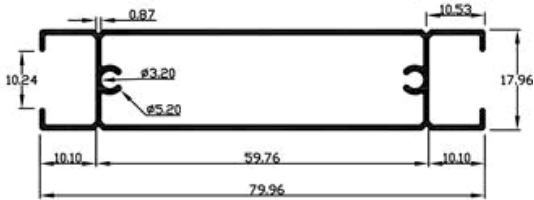

WEIGHT:- 1.900 kg/12'

## 3/4 SERIES ( W )

## 15011

SEC. NO:-15011

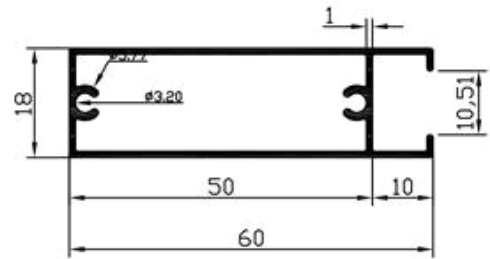

WEIGHT:- 1.763 kg/12'

## 3/4 SERIES ( W )

## 15016

SEC. NO:-15016

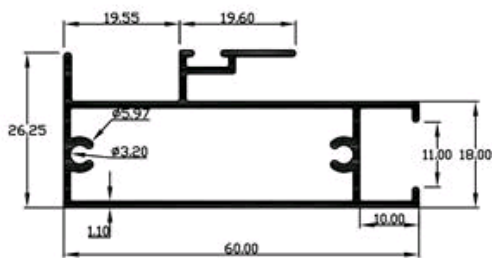

WEIGHT:- 2.383 kg/12'

## 3/4 SERIES ( W )

## 15021

SEC. NO:-15021

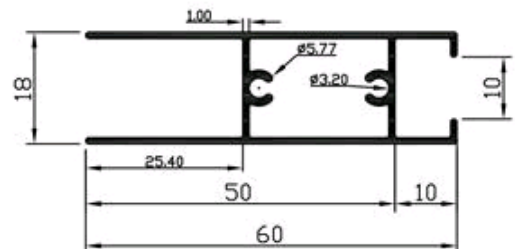

WEIGHT:- 1.767 kg/12'

## 3/4 SERIES ( W )



# NATIONAL INDUSTRIES

**15036**

SEC. NO:-15036

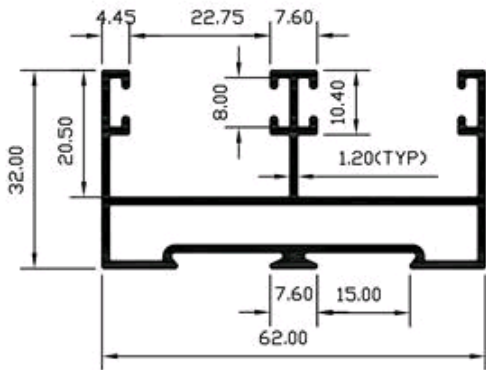

WEIGHT:- 3.000-3.300 kg/12'

**3/4 SERIES ( W )**

**15041**

SEC. NO:-15041

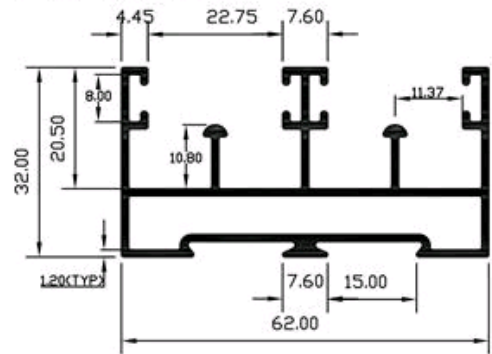

WEIGHT:- 3.300-3.500 kg/12'

**3/4 SERIES ( W )**

**15486**

SEC. NO:-15486

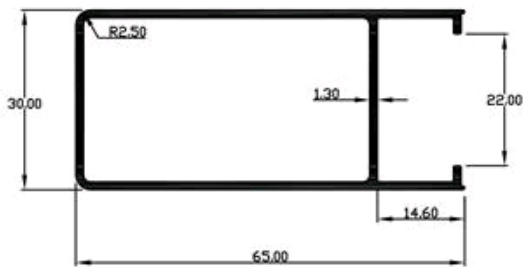

WEIGHT:- 2.420 kg/12'

**30 MM INDIAN SERIES (WINDOW)**

**15491**

SEC. NO:-15491

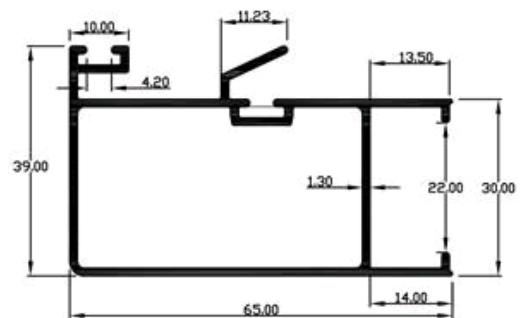

WEIGHT:- 3.060 kg/12'

**30 MM INDIAN SERIES (WINDOW)**

# NATIONAL INDUSTRIES

**15496**

SEC. NO:-15496

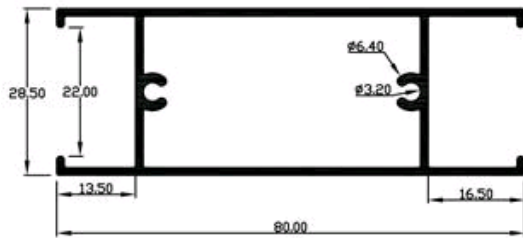

WEIGHT:- 3.080 Kg/12'

**30 MM INDIAN SERIES (WINDOW)**

**15501**

SEC. NO:-15501

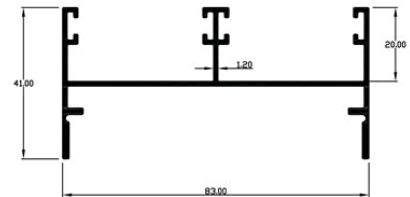

WEIGHT:- 2.978 kg/12'

**30 MM INDIAN SERIES (WINDOW)**

**15506**

SEC. NO:-15506

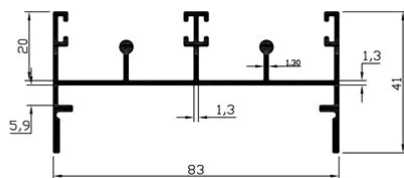

WEIGHT:- 3.434 kg/12'

**30 MM INDIAN SERIES (WINDOW)**

**15511**

SEC. NO:-15511

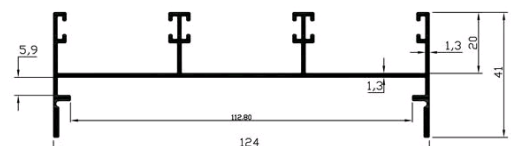

WEIGHT:- 3.975 kg/12'

**30 MM INDIAN SERIES (WINDOW)**

# NATIONAL INDUSTRIES

15516

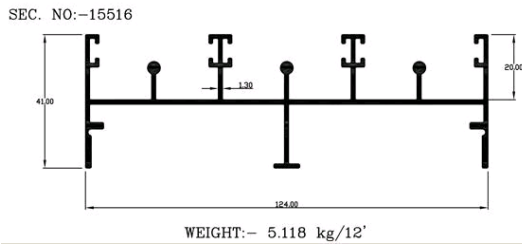

30 MM INDIAN SERIES (WINDOW)

15871

SEC. NO:-15871

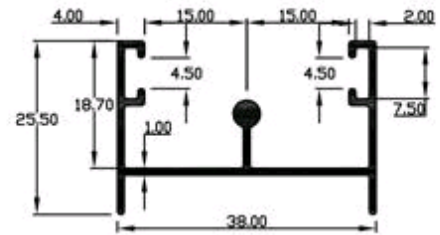

3/4 SERIES ( W )

15922

SEC. NO:-15922

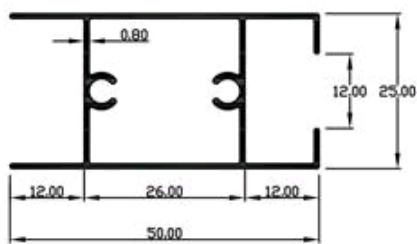

1" SERIESE ( W )

16101

SEC. NO:-16101

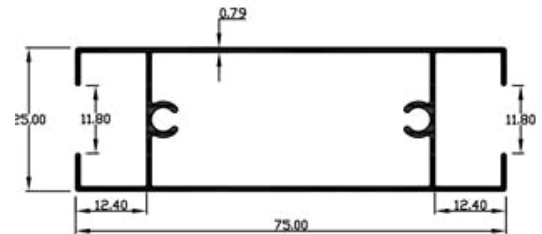

1" SERIESE ( W )

# NATIONAL INDUSTRIES

**16512**

SEC. NO:-16512

N-483

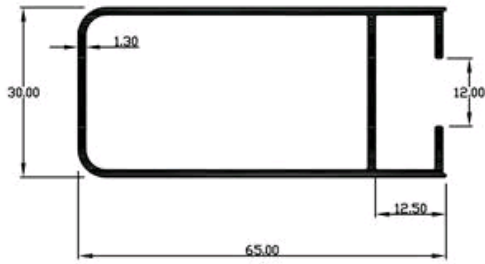

WEIGHT:- 2.515 kg/12'

**30 MM INDIAN SERIES (WINDOW)**

**16513**

SEC. NO:-16513

N-484

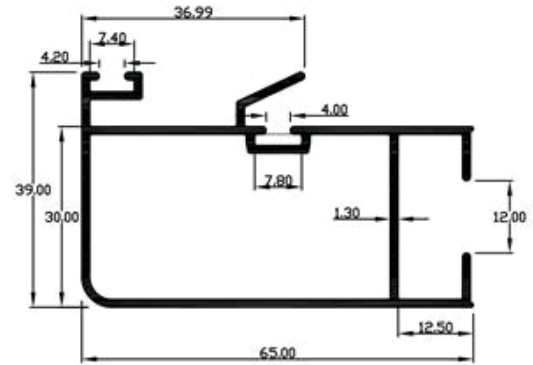

WEIGHT:- 3.172 kg/12'

**30 MM INDIAN SERIES (WINDOW)**

**16514**

SEC. NO:-16514

N-485

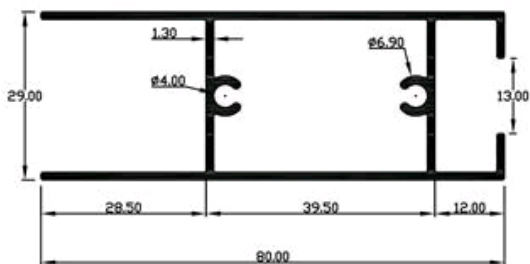

WEIGHT:- 3.196 kg/12'

**30 MM INDIAN SERIES (WINDOW)**

**16848**

SEC. NO:-16848

N-666

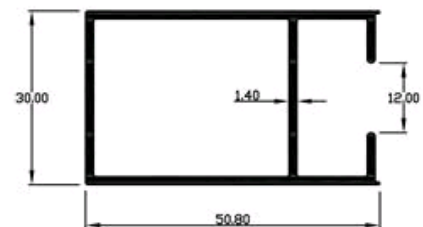

WEIGHT:- 2.351 kg/12'

**30 MM INDIAN SERIES (WINDOW)**

# NATIONAL INDUSTRIES

16849

SEC. NO:-16849

N-667

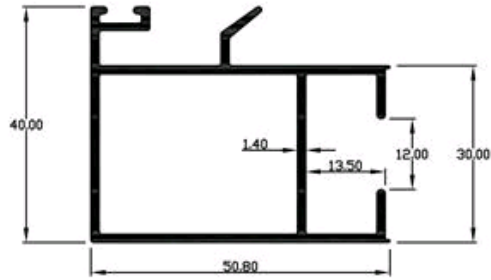

WEIGHT:- 2.826 kg/12'

30 MM INDIAN SERIES (WINDOW)

16850

SEC. NO:-16850

N-668

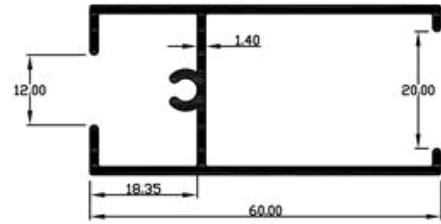

WEIGHT:- 2.452 kg/12'

30 MM INDIAN SERIES (WINDOW)