

NATIONAL INDUSTRIES

13201

SEC. NO:-13201

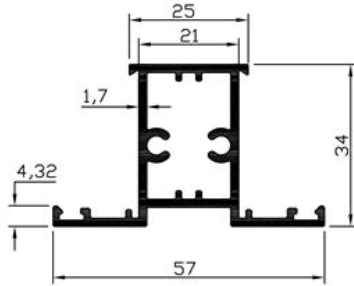

WEIGHT:- 2.950-3.200 kg/12'

Z SECTION (W)

13206

SEC. NO:-13206

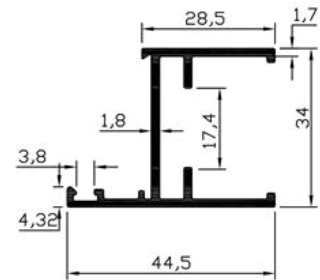

WEIGHT:- 2.100-2.300 kg/12'

Z SECTION (W)

13211

SEC. NO:- 13211

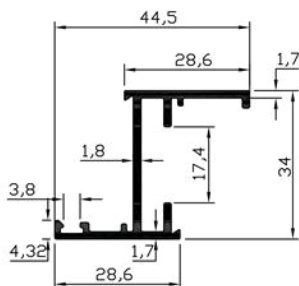

WEIGHT:- 1.850-2.000 kg/12'

Z SECTION (W)

13216

SEC. NO:- 13216

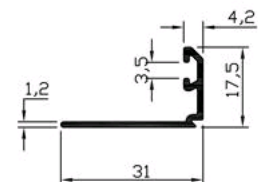

WEIGHT:- 0.650-0.700 kg/12'

Z SECTION (W)

NATIONAL INDUSTRIES

13301

SEC. NO:-13301

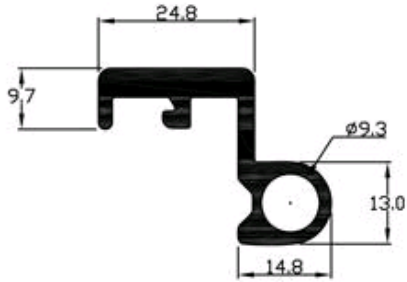

WEIGHT:- 2.500-2.800 kg/12'

Z SECTION (W)

13306

SEC. NO:-13306

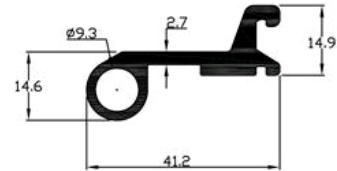

WEIGHT:- 2.350-2.650 kg/12'

Z SECTION (W)

13311

SEC. NO:-13311
SEC. NO:- P-34

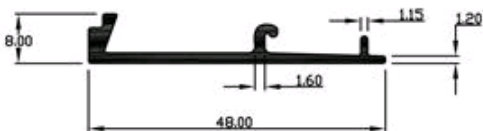

WEIGHT:- 0.950-1.150 kg/12'

Z SECTION (W)

13316

SEC. NO:-13316

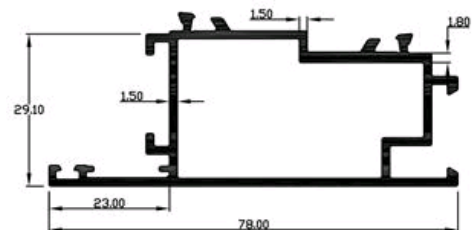

WEIGHT:- 3.640 kg/12'

Z SECTION (W)

NATIONAL INDUSTRIES

13321

SEC. NO:-13321

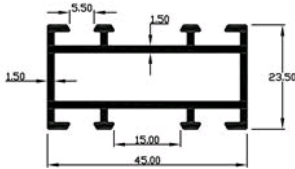

WEIGHT:- 2.500-2.800 kg/12'

Z SECTION (W)

13326

SEC. NO:-13326

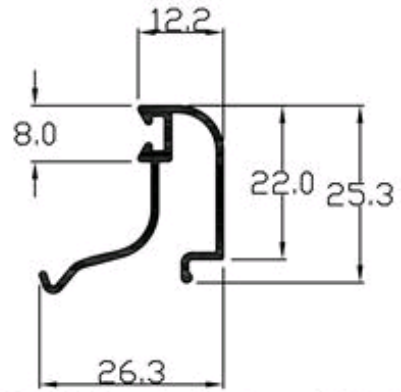

WEIGHT:- 0.750-1.000 kg/12'

Z SECTION (W)

13331

SEC. NO:-13331

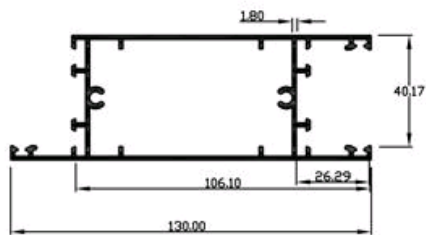

WEIGHT:- 6.400-6.700 kg/12'

Z SECTION (W)

13336

SEC. NO:-13336

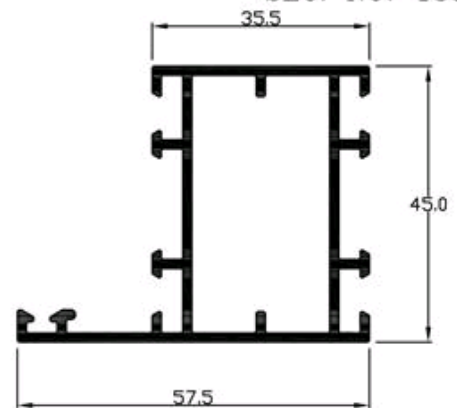

WEIGHT:- 3.400-3.700 kg/12'

Z SECTION (W)

NATIONAL INDUSTRIES

13341

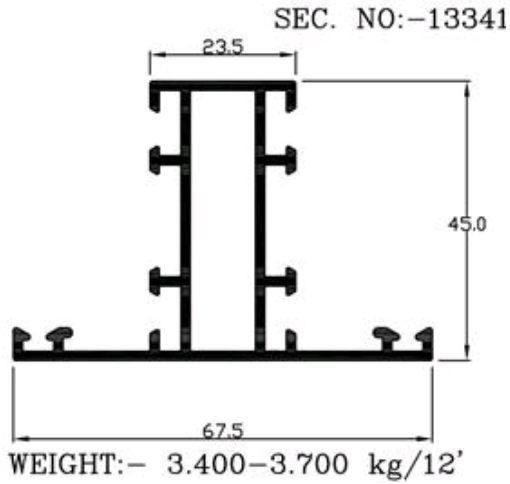

Z SECTION (W)

13346

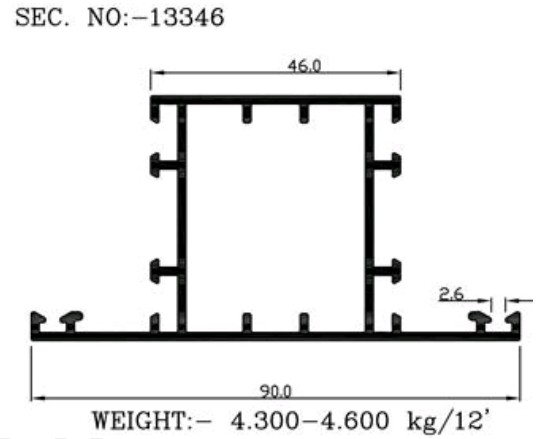

Z SECTION (W)

13351

SEC. NO:-13351

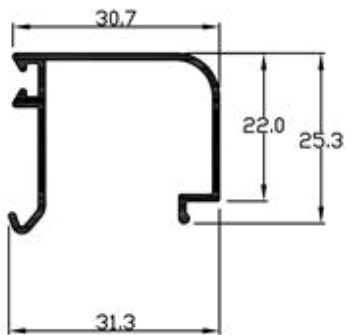

Z SECTION (W)

13376

SEC. NO:-13376

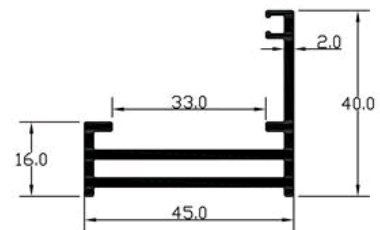

Z SECTION (W)

NATIONAL INDUSTRIES

13381

SEC. NO:-13381

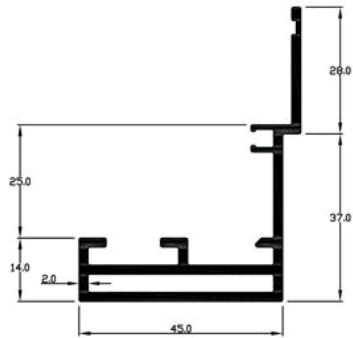

WEIGHT:- 3.600-3.900 kg/12'

Z SECTION (W)

13386

SEC. NO:-13386

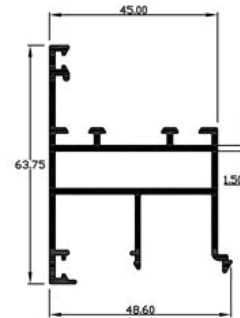

WEIGHT:- 3.600-3.900 kg/12'

Z SECTION (W)

13391

SEC. NO:-13391

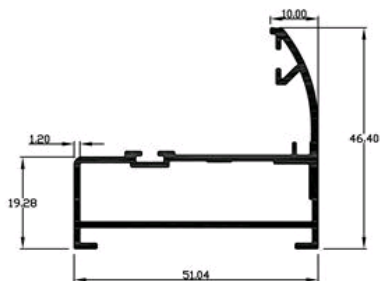

WEIGHT:- 2.400-2.700 kg/12'

Z SECTION (W)

13441

SEC. NO:-13441

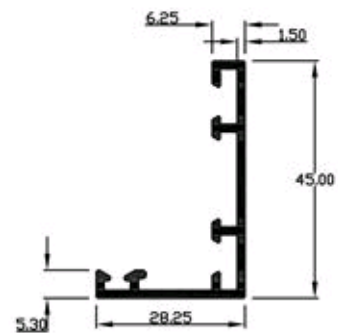

WEIGHT:- 1.600-1.900 kg/12'

Z SECTION (W)

NATIONAL INDUSTRIES

14321

SEC. NO:-14321

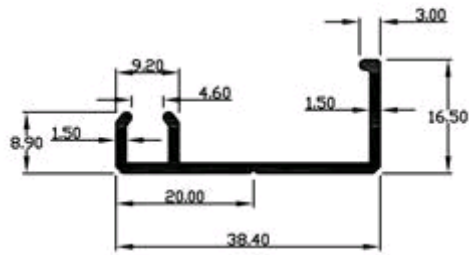

0.495 kG/12'

Z SECTION (W)

14326

SEC. NO:-14326

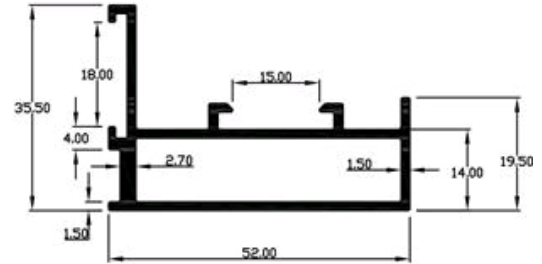

WEIGHT:- 2.687 kg/12'

Z SECTION (W)

14331

SEC. NO:-14331

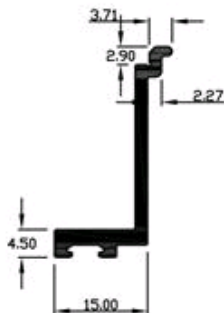

WEIGHT:- 1.112 kg/12'

Z SECTION (W)

14336

SEC. NO:-14336

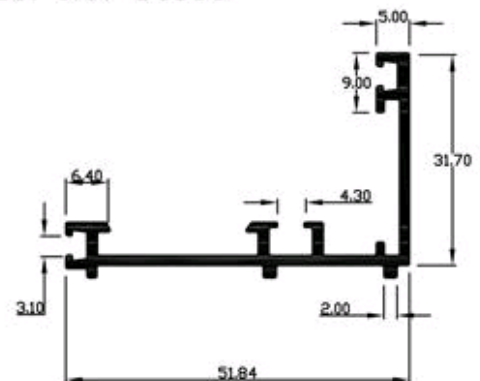

WEIGHT:- 1.846 kg/12'

Z SECTION (W)

NATIONAL INDUSTRIES

14341

SEC. NO:-14341

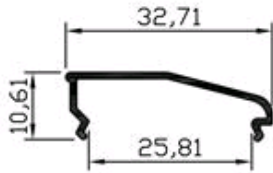

WEIGHT:- 0.500-0.600 kg/12'

Z SECTION (W)

14376

SEC. NO:-14376

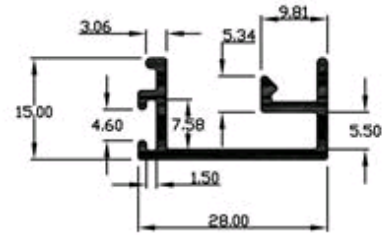

WEIGHT:- 0.713 kg/12'

Z SECTION (W)

14436

SEC. NO:-14436

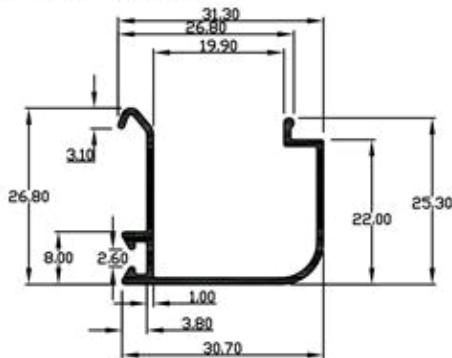

WEIGHT:- 0.960 kg/12'

Z SECTION (W)

14826

SEC. NO:-14826

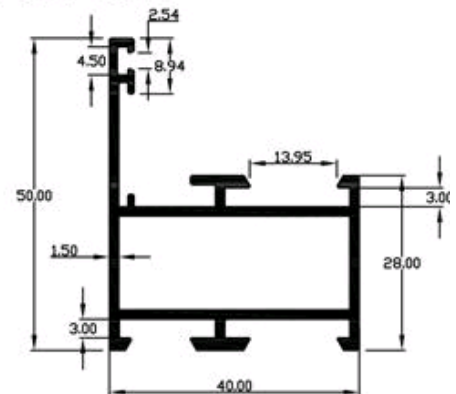

WEIGHT:- 2.877 kg/12'

Z SECTION (W)

NATIONAL INDUSTRIES

14831

SEC. NO:-14831

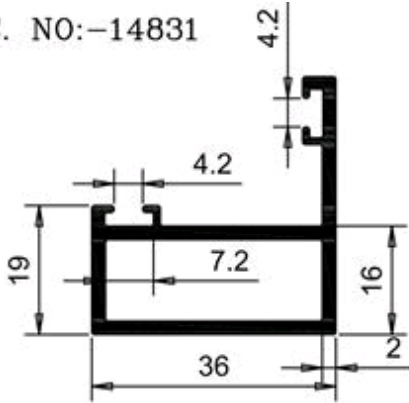

WEIGHT:- 2.550 kg/12'

Z SECTION (W)

15331

SEC. NO:-15331

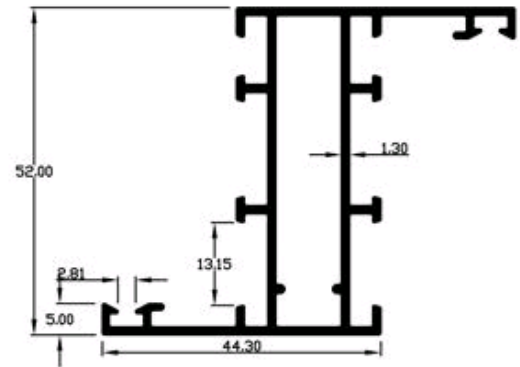

WEIGHT:- 3.252 kg/12'

Z SECTION (W)

15336

SEC. NO:-15336

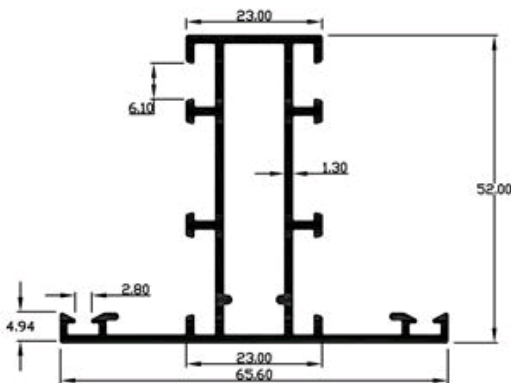

WEIGHT:- 3.252 kg/12'

Z SECTION (W)

15341

SEC. NO:-15341

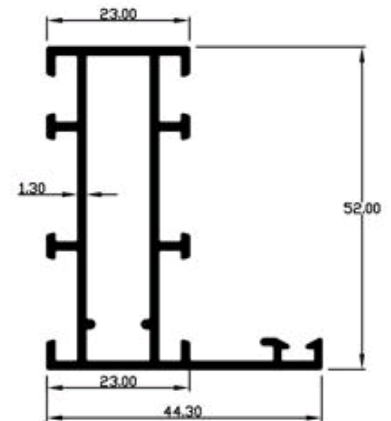

WEIGHT:- 2.856 kg/12'

Z SECTION (W)

NATIONAL INDUSTRIES

15346

SEC. NO:-15346

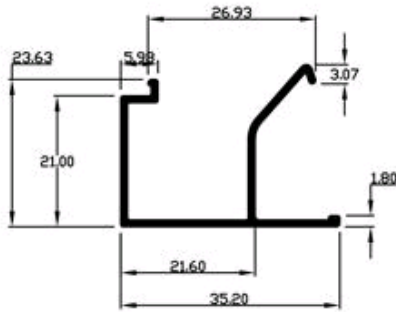

WEIGHT:- 1.026 kg/12'

Z SECTION (W)

16027

SEC. NO:-16027

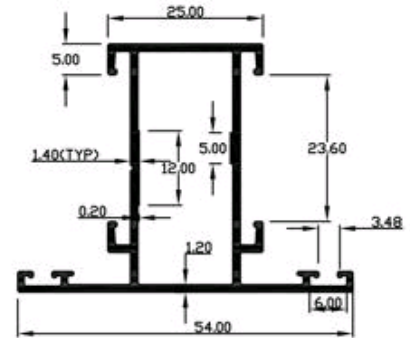

WEIGHT:- 2.257 kg/12'

Z SECTION (W)

16129

SEC. NO:-16129

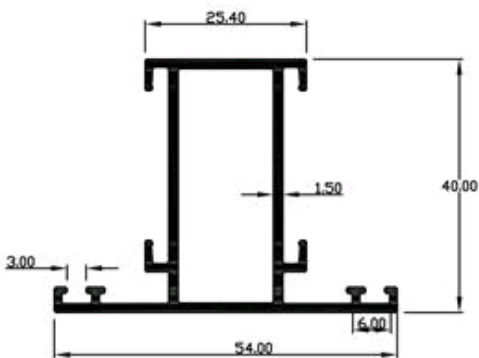

WEIGHT:- 2.654 kg/12'

Z SECTION (W)

16131

SEC. NO:-16131

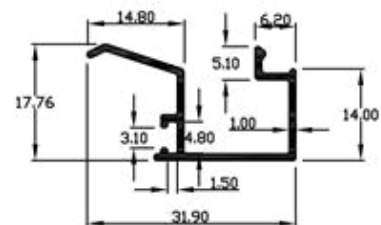

WEIGHT:- 0.756 kg/12'

Z SECTION (W)

NATIONAL INDUSTRIES

16139

SEC. NO:-16139

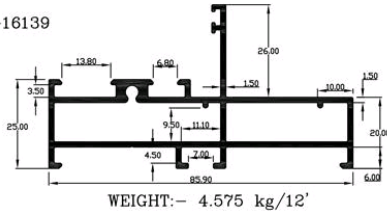

WEIGHT:- 4.575 kg/12'

Z SECTION (W)

16140

SEC. NO:-16140

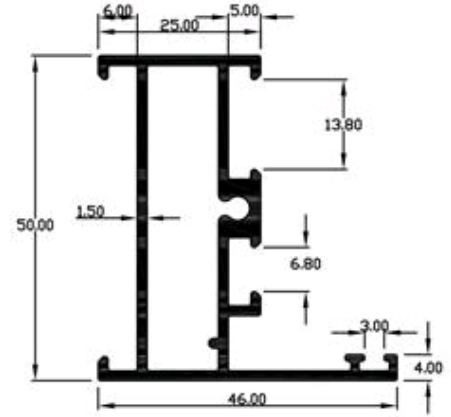

WEIGHT:- 3.087 kg/12'

Z SECTION (W)

16141

SEC. NO:-16141

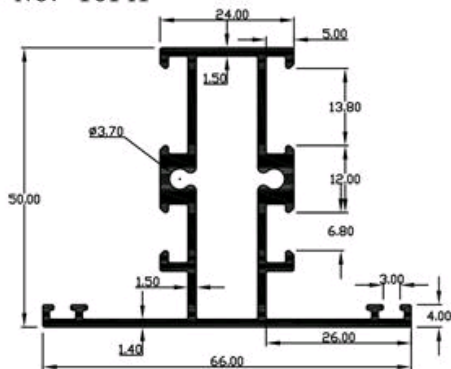

WEIGHT:- 3.795 kg/12'

Z SECTION (W)

16142

SEC. NO:-16142

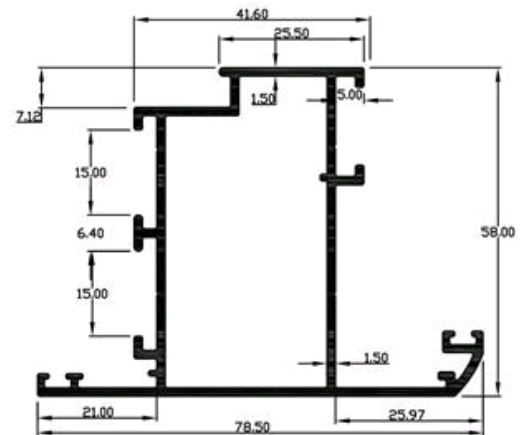

WEIGHT:- 4.200 kg/12'

Z SECTION (W)

NATIONAL INDUSTRIES

16143

SEC. NO:-16143

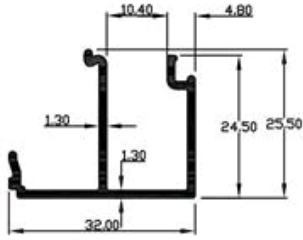

WEIGHT:- 1.191 kg/12'

Z SECTION (W)

16152

SEC. NO:-16152

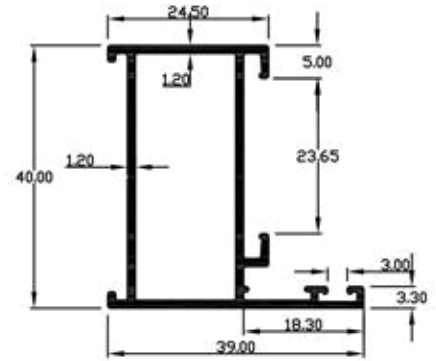

WEIGHT:- 1.876 kg/12'

Z SECTION (W)

16153

SEC. NO:-16153

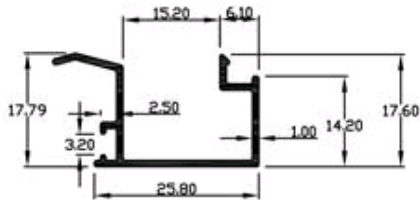

WEIGHT:- 0.770 kg/12'

Z SECTION (W)

16213

SEC. NO:-16213

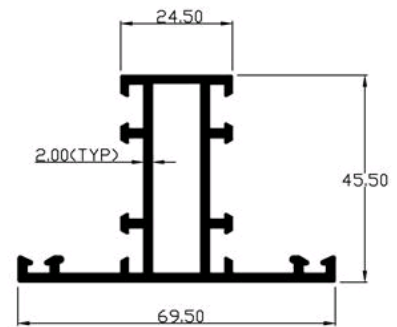

WEIGHT:- 4.555 kg/12'

Z SECTION (W)

NATIONAL INDUSTRIES

16214

SEC. NO:-16214

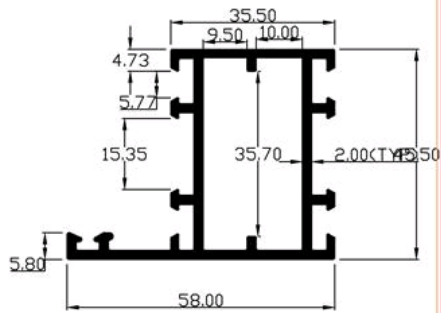

WEIGHT:- 4.460 kg/12'

Z SECTION (W)

16489

SEC. NO:-16489

N-469

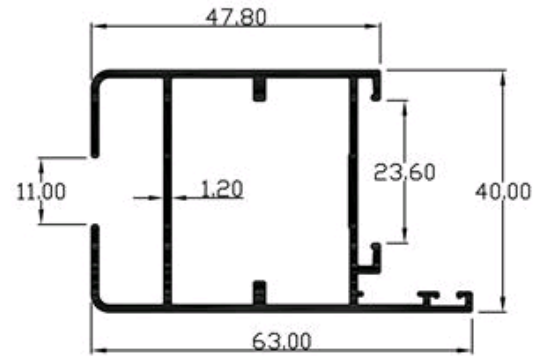

WEIGHT:- 2.874 kg/12'

Z SECTION (W)

16521

SEC. NO:-16521

IND-98

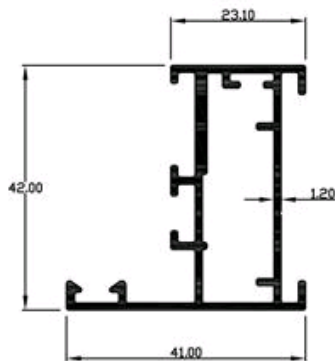

WEIGHT:- 2.405 kg/12'

Z SECTION (W)

16522

SEC. NO:-16522

IND-99

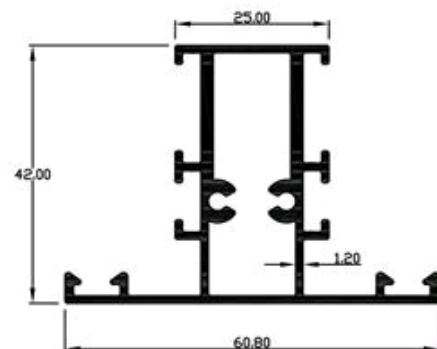

WEIGHT:- 3.260 kg/12'

Z SECTION (W)

NATIONAL INDUSTRIES

16523

SEC. NO:-16523

IND-100

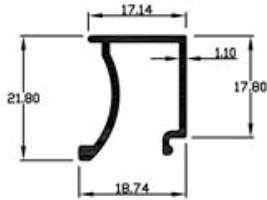

WEIGHT:- 0.732 kg/12'

Z SECTION (W)

16524

SEC. NO:-16524

IND-106

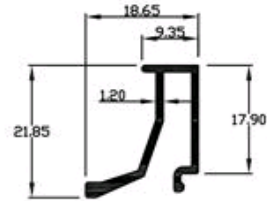

WEIGHT:- 0.725 kg/12'

Z SECTION (W)